

---

**Title**

---

Field of Application for:  
The Flamebreak Range of Doorsets  
Using Timber Based Door Blanks  
in Timber Based Door Frames

For 30 minutes Fire Resistance

---

**Report No.:**

---

FEA98164 Revision P

---

**Issue Date:**

---

27<sup>th</sup> August 2024

---

**Valid Until:**

---

27<sup>th</sup> August 2029

---

**Job Reference:**

---

WF544569

---

**Prepared for:**

---

**Pacific Rim Wood Ltd**

Ground Floor Suite  
Block B, Old Kelways  
Somerton Road  
Langport  
Somerset  
TA10 9SJ

---

## Contents

## Page No.

Contents .....	2
1 Foreword .....	4
2 Proposal .....	5
2.1 Assumptions .....	5
3 Test Data.....	6
3.1 Primary Test Evidence .....	7
3.2 Supporting Test Data .....	8
4 Technical Specification.....	10
4.1 General .....	10
4.2 Intended Use.....	10
4.3 Door Leaf .....	10
4.4 Door Frames .....	11
4.5 Doorset Configurations & Maximum Leaf Sizes.....	12
5 General Description of Construction .....	59
5.1 Leaf Core Construction .....	59
5.2 Leaf Edging Materials.....	59
5.3 Leaf Facings Materials .....	62
5.4 Decorative Planted on Timber Mouldings – all Leaf Types .....	63
5.5 Feature Grooves .....	63
5.6 PVC Edge Protectors & Post-Formed CS Group Acrovyn .....	64
6 Glazing within the Leaf .....	66
6.1 General .....	66
6.2 Certifire Single Pane Glass and Glazing System Options.....	67
6.3 Tested Glazing System .....	68
6.4 Pneumatically Fired Pins – Glazing Pins for Glazing Within the Leaf.....	69
6.5 Improved Security Bead .....	71
6.6 Norsound Single Pane Glass & Glazing Systems – Leaf types 1 – 6.....	72
6.7 Double Glazed Units & Glazing Systems – Leaf types 1 & 2 only.....	75
7 Door Frame Construction .....	75
7.1 Details for Frame 1 & 2 .....	75
7.2 Threshold .....	77
7.3 Door Frame Joints.....	78
7.4 Decorative Facings – All Frame Options .....	79
8 Overpanels & Fanlights & Sidelights.....	79
8.1 General .....	79
8.2 Framing.....	79

8.3	Glazed Fanlights & Sidelights.....	85
9	Adhesives.....	95
10	Hardware.....	95
10.1	General.....	95
10.2	Intumescent to Hardware .....	96
10.3	Essential Hardware .....	97
10.4	Latches & Locks.....	98
10.5	Handles & Escutcheons .....	103
10.6	Butt Hinges .....	104
10.7	Doorset Self Closing .....	105
10.8	Bolts.....	108
10.9	Non-Essential Hardware .....	109
11	Installation .....	115
11.1	General.....	115
11.2	Door Frame Installation .....	115
11.3	Firestopping .....	116
11.4	Packers.....	117
11.5	Wall Types, Structural Opening & Fixity .....	118
11.6	Post Production (Onsite) Leaf Size Adjustment.....	120
11.7	Door Gaps.....	121
12	Insulation Performance.....	121
13	Conclusion .....	121
14	Declaration by the Applicant .....	122
15	Limitations .....	123
16	Validity.....	124
	Appendix A Summaries of Supporting Test Evidence .....	125
	Appendix B Revisions.....	153

## 1 Foreword

This Field of application report has been commissioned by Pacific Rim Wood Ltd and relates to the fire resistance of Flamebreak 30 minute doorset designs, a construction manufactured by P.T. Kutai Timber of Indonesia.

The report is for national application and has been written in accordance with the general principles outlined in BS EN 15725.

This Field of Application (scope) uses established empirical methods of extrapolation and experience of fire testing similar doorsets, in order to extend the scope of application by determining the limits for the designs based on the tested constructions and performances obtained. The scope is an evaluation of the potential fire resistance performance if the variations specified herein were to be tested in accordance with BS 476 Part22:1987.

This scope document cannot be used as supporting documentation for either a UKCA or CE marking application, nor can the conclusion be used to establish a formal classification against EN13501-2.

This Field of Application has been written using appropriate test evidence generated at UKAS accredited laboratories<sup>1</sup>, to the relevant test standard. The supporting test evidence has been deemed appropriate to support the manufacturers stated door design and is summarised in section 3.

The scope presented in this report relates to the behaviour of the proposed door design variations under the particular conditions of the test; they are not intended to be the sole criterion for considering the potential fire hazard of the door assembly in use.

This Field of Application has been prepared and checked by product assessors with the necessary competence, who subscribe to the principles outlined in the Passive Fire Protection Forum (PFPF) 'Guide to Undertaking Technical Assessments of the Fire Performance of Construction Products Based on Fire Test Evidence'. The aim of the PFPF guidelines is to give confidence to end-users that assessments that exist in the UK are of a satisfactory standard to be used for building control and other purposes.

Certifire and/or assessment supporting documentation has been used to enhance the scope of application within this evaluation. At the time of issue of this document, the relevant documentation has remaining validity. The referenced supporting documentation must retain validity, with the same conclusions maintained for the aspects considered herein, in order that the relevant scope generated within this field of application report remains valid. This may necessitate a review of more recent iterations of supporting documentation, against those referenced in this assessment report. If the scope of the relevant supporting documentation changes, then Warringtonfire must be consulted to review the changes, and to consider their effect on the outcomes of this assessment report.

The drawings provided in this report are for guidance and illustrative purposes only. Please note that the written scope of application takes precedence.

<sup>1</sup> Test evidence from overseas laboratories has also been considered as supporting evidence for the designs in this assessment report. The test evidence is from a laboratory that has been accredited by a national accreditation body that is a signatory of the International Laboratories Accreditation Co-operation (ILAC).

## 2 Proposal

It is proposed to consider the fire resistance performance of the specified proprietary Flamebreak doorset designs, for 30 minutes fire resistance integrity performance (and where appropriate insulation performance), if the doorset designs were to be tested to the requirements of BS476 Part22: 1987, *Methods for determination of the fire resistance of non-loadbearing elements of construction*.

The field of application defined in this report is based on the fire resistance test evidence for the doorset design, which is summarised in section 3. Analysis of specific construction details that require assessment are given within this report against the relevant element of construction, as appropriate.

Whilst specific items are included within this Field of Application report that may be used to provide additional performance characteristics (such as acoustic or smoke control for example), it is beyond the remit of this Field of Application report to provide scope for performance characteristics other than fire resistance integrity and (where applicable) insulation performance. Any other performance requirement for the door designs contained herein is to be subject to a separate analysis.

### 2.1 Assumptions

- All densities referred to in this document are based upon an assumed moisture content of 12%.
- It is assumed that unless otherwise documented in the field of application sections of this report, the doorset subject to this report will be constructed in accordance with the test evidence referred to herein.
- For components created using solid timber sections referred to in this assessment, it is assumed that, for all timbers, they will be of a quality deemed to meet or exceed class J30 as specified in BS EN 942: 2007, subject to adequate repairs, other than glazing beads which must meet a minimum class J10. Note that areas under intumescent seals/gaskets are not considered to be concealed faces and defects must be repaired.
- Where timber is referred to within this document it is assumed that the timber element is made from a continuous solid piece, unless specifically detailed otherwise.
- All dimensions detailed herein may be varied by  $\pm 2\%$  except where minimum, maximum or a range of dimensions are given.
- Where morticed items of hardware are used (within the leaf or frame) it is assumed that the preparation for such items are tight to the item (and where applicable intumescent protection) as tested with no excessive gaps, unless stated otherwise within a particular section of this report.

### 3 Test Data

The test evidence summarised below has been generated to support the fire resistance performance of the door designs that are the subject of this field of application. The summary details are considered to be the key aspects of the design tested. These test summaries are not intended to be a definitive guide to constructing a doorset. The details for the construction of a doorset must be taken from other sections within this Field of Application.

#### Note:

1. Dimensions are in mm unless otherwise stated.
2. Abbreviations: (h) = height; (w) = width; (t) = thickness; (d) = deep; (l) = long.
3. Latches fitted but disengaged for the test, are reported as 'unlatched'.

The test evidence has been generated across a number of different doorset configurations, including single leaf, double leaf, latched and unlatched doorsets as well as doorsets with sidescreens and overpanels.

Some of the test evidence used in the evaluation is over 5 years old. In accordance with industry guidance, the evidence has been reviewed to consider its suitability. Warringtonfire are satisfied that there have been no significant revisions to the relevant test standards which would render the evidence irrelevant.

The evidence has been generated to BS 476 Part 22: 1987 and EN 1634-1. The latter is known to be more onerous than the BS 476: Part 22: 1987 standard, primarily due to the use of plate thermocouples within the furnace to record the furnace temperature.

The same time temperature curve is used to control the temperature within the furnace for both test methods (the heating curve given within ISO 834-1). However, the plate thermocouple used to record the temperature within the furnace for the EN test method, requires a longer thermal exposure to read the same temperature as the probe thermocouple that is used for the BS 476: Part 22: 1987 test, particularly during the early stages of the test. Furthermore, the neutral pressure regime is positioned lower relative to the specimen height in a European fire door test, therefore resulting in greater relative positive pressure conditions than those expected in a BS 476-22: 1987 test, which has the potential to increase hot gases and flaming on the unexposed side. These factors result in more onerous test conditions for doorsets tested to the BS EN 1634-1 test standard compared with the BS 476: Part 22: 1987 test standard, which has been demonstrated by testing the same products to both standards.

It is therefore the opinion of Warringtonfire that the evidence cited in the following section, tested to both named standards referenced above can be utilised in this assessment which will conclude in terms of the fire resistance performance of the Flamebreak doorset designs if tested in accordance with BS 476: Part 22: 1987.

A number of the test reports cited have been supplied by sponsors other than Pacific Rim Wood Ltd. The test evidence is based on the same type of door core as that contained within this assessment and has been deemed suitable to increase the scope of the doorsets designs tested by Pacific Rim Wood Ltd. Permission has been obtained from the owners of the test data to reference it herein to increase the scope as discussed above.

### 3.1 Primary Test Evidence

The following data is provided to give the key details relevant to the tested specimen. Throughout this assessment report, relevant sections will reference the tests where they have been used to provide the scope of application.

[See Appendix A for detailed Test Summaries](#)

Report No.	Configuration	Leaf Size (mm)	Test Standard	Performance (mins)
18-003111-PR04	LSASD	2150 x 926 x 44	BS 476 Part 22: 1987	Integrity 34 Insulation: 29
Test is presented as primary test data for the Flamebreak 430 design incorporating a 3-pt lock and an IGU				
WF403587	A: ULSASD	2040 x 826 x 44	BS 476 Part 22: 1987	Integrity 47 Insulation: 47
Test is presented as direct test evidence of the Flamebreak design opening away from furnace heating conditions				
WF381914	B: ULSADD	2155 x 936/680 x 44	BS 476 Part 22: 1987	Integrity 44 Insulation: 44
Test is presented as primary test data for the Flamebreak 430 design utilising Sealed Tight Solutions leaf edge intumescent seals				
RF98033	ULSADD	2135 x 915 x 45	BS 476 Part 22: 1987	36
Test is presented as primary test data for the Flamebreak design utilising Lorient Polyproducts Ltd Type617 seals without lippings installed				
RF98075	2No. ULSASD	A = 2055 x 865 x 44 B = 2135 x 916 x 44	BS 476 Part 22: 1987	A = 31 B = 33
Test is presented as primary test data for the Flamebreak design utilising Lorient Polyproducts Ltd Type617 seals				
RF00044	A: ULSASD	2080 x 915 x 44	BS 476 Part 22: 1987	A = 31
Test is presented as primary test data for the Flamebreak design with stiles and rails but without lippings				
RF00046	ULSADD	2135 x 835 x 44	BS 476 Part 22: 1987	32
Test is presented as primary test data for the Flamebreak type 6 design without stiles and with lippings on vertical edges only				
RF00098	2No. ULSASD	A = 2080 x 916 x 44 B = 2080 x 860 x 44	BS 476 Part 22: 1987	A = 32 B = 33
Test is presented as primary test data for the Flamebreak design with stiles and top rail and without lippings				
RF00166	ULSASD	A = 2440 x 1220 x 44 B = 2390 x 1154 x 44	BS 476 Part 22: 1987	A = 37 B = 41
Test is presented as supporting test data for the Flamebreak design comparing similar specimens lipped and unlipped				

RF04011	LSASD	1976 x 758 x 44	BS 476 Part 22: 1987	31
Test is presented as primary test data for the Flamebreak design utilising graphite seals with lippings on all edges				
WF522957	A: ULSASD	2045 x 927 x 44	BS EN 1634-1: 2014+A1:2018	A: 36
	B: ULSASD	2047 x 929 x 44		B: 36
Test is presented as supporting data support introduction of the Rutland ITS11204 concealed closer and multiple glazed apertures				
WF535889	A: LSASD	A&B: 2040 x 926 x 44	BS EN 1634-1: 2014+A1:2018	A: 39
	B: ULSASD			A: 39
Test is presented as supporting data support alternative lockset requirements and fanlight and sidelight framing.				

### 3.2 Supporting Test Data

See Appendix A for selected, detailed Test Summaries

Report No.	Configuration	Leaf Size (mm)	Test Standard	Performance (mins)
RF08100	A: ULSADD	2100 x 900/350 x 44	BS 476: Part 22: 1987	A: 39
	B: ULSASD	2100 x 900 x 44	BS 476: Part 22: 1987	B: 51
Test is presented as supporting data with specimen utilising a P.U glueline for lipping, glazed apertures – ply and MDF faces				
RF05041	ULSASD	2041 x 825 x 44	BS 476: Part 22: 1987	39
Test is presented as supporting data with for the Flamebreak design having stiles removed & lipped on vertical edges only with rebated meeting edges				
RF08116	A: ULSASD	2040 x 826 x 44	BS 476: Part 22: 1987	A: 45
	B: ULSASD	2040 x 826 x 44	BS 476: Part 22: 1987	B: 35
Test is presented as supporting data with specimen utilising 10 x 4 Pyroplex seals with ply and MDF faces				
RF08118	ULSADD + OP	2400 x 1000 x 44 + 400 OP	BS 476: Part 22: 1987	41
Test is presented as supporting data - specimen comprised ply face leaves with flush overpanel and rebated head junction using Pyroplex seals				



RF10149	ULSADD + OP	2130 x 930 x 44 + 400 OP	BS 476: Part 22: 1987	33 (failure at lock – perimeter failure at 38)
Test is presented as supporting data for ply faced Flamebreak doorsets				
RF11026	LSASD	2761 x 1236 x 44	BS 476: Part 22: 1987	39
Test is presented as supporting data - specimen comprised ply face leaves with no perimeter stiles or rails				
Warres 316266	LSASD	1490 x 1490 x 44	BS 476: Part 20: 1987	33
Test is presented as supporting data for doorsets installed in softwood framed glazed screen, both incorporating the Lorient Polyproducts Ltd System 36 Plus glazing system				
WF504980	A & B: LSASD	A & B: 2150 x 930x 44	BS EN 1634-1: 2014+A1:2018	A open in: 48
				B open out: 35
Test is presented as supporting data for additional scope for intumescent materials and hardware items				
WF504981	A & B: LSASD	A & B: 2115 x 860x 44	BS EN 1634-1: 2014+A1:2018	A open in: 44
				B open out: 29
Test is presented as supporting data for additional scope for intumescent materials and hardware items				
PF14207 Revision B	B: ULSADD	B: 1980 x 837 x 44	BS 476: Part 22: 1987	B: 30
PF14207 Revision B is presented as the primary data for - ST105GT 10mm x 5mm glazing systems and ST100x25 & ST140x50 hardware gaskets for protecting hardware at 30 minutes performance.				
PF15160	LSADD	2040 x 926 x 44	BS 476: Part 22: 1987	20*
Test is presented as supporting data for additional scope for ST105GT and ST105GT(3) glazing systems. * Initial failure was recorded at the glazed aperture of the left leaf which utilised Pyro stem glass. The equally sized, glazed aperture in the right leaf did not exhibit integrity failure until 38 minutes and was glazed with AGC Pyrobelite 7 glass.				
RF10128	A: ULSASD	2100 x 1000 x 44	BS 476: Part 22: 1987	A: 44
	B: ULSADD	2696 x 950/445 x 54		B: 65
Test is presented as supporting data for Flamebreak doorsets incorporating the Norsound NOR810S threshold dropseal				

## 4 Technical Specification

### 4.1 General

The technical specification for the proposed door assemblies is given in the following sections and is based on the test evidence for the door designs, summarised in section 3.

### 4.2 Intended Use

The intended use of the proposed door assembly is summarised below:

A pedestrian doorset including any frame, door leaf or leaves which is provided to give a fire resisting capability when used for the closing of permanent openings in fire resisting separating elements, which together with the building hardware and any seals (whether provided for the purpose of fire resistance or smoke control or for other purposes such as draught or acoustics) form the assembly.

### 4.3 Door Leaf

Doorsets constructed using the different leaf options can include various design features as summarised below.

Specific sections within this assessment must be referred to for design limitations and construction requirements.

Section 5 gives the description of each leaf type in terms of composition and density etc.

#### 4.3.1 Leaf 1 – Flamebreak 30 – 4mm thick Ply facings

This leaf type can include:

1. Glazing
2. Various hardware options
3. Decorative facings
4. Decorative planted on timber mouldings.

#### 4.3.2 Leaf 2 – Flamebreak 30 – 6mm thick Ply facings

This leaf type can include:

1. Glazing
2. Various hardware options
3. Decorative facings
4. Decorative planted on timber mouldings.

#### 4.3.3 Leaf 3 – Flamebreak 30 – 9mm thick Ply facings

This leaf type can include:

1. Glazing
2. Various hardware options
3. Decorative facings
4. Decorative planted on timber mouldings.

#### **4.3.4 Leaf 4 – Flamebreak 30 – 4, 6 and 9mm thick chipboard facings**

This leaf type can include:

1. Glazing
2. Various hardware options
3. Decorative facings
4. Decorative planted on timber mouldings.

#### **4.3.5 Leaf 5 – Flamebreak 30 – 6mm thick MDF facings**

This leaf type can include:

1. Glazing
2. Various hardware options
3. Decorative facings
4. Decorative planted on timber mouldings.

#### **4.3.6 Leaf 6 – Flamebreak 30 – 9mm thick MDF facings**

This leaf type can include:

1. Glazing
2. Various hardware options
3. Decorative facings
4. Decorative planted on timber mouldings.

### **4.4 Door Frames**

Doorsets constructed using different frame options can include various design features as summarised below.

Specific sections within this assessment must be referred to for design limitations and construction requirements, where applicable.

#### **4.4.1 Frame 1 – Softwood or Hardwood Timber – for use with all Leaf Options**

The construction of the door frames is softwood or hardwood with minimum frame dimensions. For further information on the specification and construction of the door frames see section 7.

#### **4.4.2 Frame 2 – MDF – for use with all Leaf Options**

The construction of the door frames is MDF with minimum frame dimensions. For further information on the specification and construction of the door frames see section 7.

## 4.5 Doorset Configurations & Maximum Leaf Sizes

### 4.5.1 General

The evaluation of the leaf size for each door leaf option and frame option and doorset configuration is based on the tests listed in Section 3 and takes into account:

1. The margin of over performance above 30 minutes integrity for the design
2. The characteristics exhibited during test and
3. The doorset configuration tested.

The evaluation of the permitted configurations included in this field of application is based on the configuration(s) tested. The principle is that the more components included in testing, for example, double door leaves and an overpanel – the harder it becomes to pass a test. In this specific example it is because the junction between two door leaves or door leaf and overpanel introduces a discontinuity into the doorset which can be a means of failure. This approach leads to the following statements:

1. A test on a double doorset is more onerous than a test on a single doorset.
2. A test on a doorset with a flush overpanel is more onerous than a test on a doorset without an overpanel. A flush overpanel has the same thickness as the door leaf and is flush with the leaf/leaves.
3. A test on an unlatched doorset is more onerous than a test on a latched doorset as the leading edge is unrestrained and will deflect more in fire test conditions.
4. A test on an unlatched single acting doorset is considered to be equivalent to a double acting doorset, due to the known deflection of an unlatched single acting doorset towards the furnace conditions i.e. away from the door stop. However, this does not cover doorsets with flush overpanels.
5. A doorset with transomed overpanel is considered to perform comparably to a similar doorset without an overpanel. This is because the transom structurally separates the overpanel from the doorset.











The leaf size for each door leaf option and configuration is linked to the perimeter intumescent specification and frame option. The following section details the maximum leaf size for each door leaf option and configuration based on the intumescent specification and frame details tested.

Doorsets with reduced height and width dimensions from those tested are deemed to be less onerous. Therefore, doors with dimensions less than those given in the leaf size envelopes (for the relevant intumescent specification) in the following sections are covered and may be manufactured.

## 4.5.2 Configuration

The table below shows the permitted configurations for the Flamebreak doorset design, with the abbreviation and full description of each configuration.

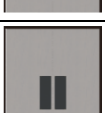
The following sections details the assessed maximum leaf size envelopes for each permitted configuration based on the intumescent specification and door frame tested.

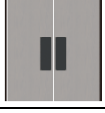
Depiction	Abbreviation	Description
	LSASD	Latched Single Acting Single Doorset
	ULSASD	Unlatched Single Acting Single Doorset
	DASD	Double Acting Single Doorset
	LSASD+OP	Latched Single Acting Single Doorset + Flush Overpanel
	ULSASD+OP	Unlatched Single Acting Single Doorset + Flush Overpanel
	DASD + OP	Double Acting Single Doorset + Flush Overpanel
	LSADD	Latched Single Acting Double Doorset
	ULSADD	Unlatched Single Acting Double Doorset
	DADD	Double Acting Double Doorset
	LSADD+OP	Latched Single Acting Double Doorset + Flush Overpanel
	ULSADD+OP	Unlatched Single Acting Double Doorset + Flush Overpanel
	DADD + OP	Double Acting Double Doorset + Flush Overpanel

### 4.5.3 Orientation

The majority of primary fire resistance tests for these designs were conducted with the doorset hung such that the door leaf opened towards the fire, which is considered the most onerous orientation in terms of fire resistance performance. Based on this testing, assessment is made that the doorsets to this design may be hung either away from or towards the fire risk side of the doorset. The rationale behind the direction of fire testing timber based doorsets opening towards the fire test conditions is further explained in Annex C of BS EN 1634-1:2014 +A1:2018.

Test WF403587 evaluated a single leaf specimen opening away from the furnace which achieved 47 minutes with no failures prior to the termination of the test, therefore validating the point made above.

### 4.5.4 Envelopes for each Configurations

The following sections detail the door leaf envelopes which indicate the permitted leaf sizes for the listed configurations based on the perimeter intumescent, door leaf option and door frame.

Unequal leaf double doorsets are covered by this assessment provided that all the following criteria are met:

- The relevant door leaf envelopes are not exceeded.
- Door leaf widths are no smaller than 300mm.

For equal double doorsets both leaves must comply with the door leaf envelope size limitations.

Single acting double doorsets are only considered acceptable when the leaves are hung to open in the same direction.

A table of essential hardware is given in section 10.3 for each doorset configuration, as a minimum requirement for the doorset described. Changes to hardware can affect the intumescent specification and frame details which are subsequently considered for each specific hardware component, where required.

#### 4.5.4.1 General Note on Intumescent Seals

- Intumescent seals are to be fitted centrally to the thickness of the leaf unless stated otherwise.
- Intumescent seals are fully interrupted at hardware locations unless stated otherwise.
- Intumescent seals must run the full length of the leaf edge or frame reveals, with tightly formed abutting corner joints, unless stated otherwise.
- Vertical perimeter intumescent seals may include one tight butt joint in their length if needed.
  - Where two seals are fitted, the joints must be offset by a minimum of 100mm and may not be coincident.
  - Where one seal is fitted the joint must be in the lower half of the doorset.
- Intumescent seals are not to be concealed below lippings.
- While intumescent seals are not specified to be applied at the bottom edge of the leaf, their application may be a requirement for certain elements of building hardware. It is the opinion of Warringtonfire that the application of intumescent seals across the bottom edge of the leaf will not detract from the fire resistance performance under test conditions, when applied the intumescent may consist of either:
  - 1No. Intumescent seal no greater than 20mm wide centrally fitted.

- Inclusion of specific design details (e.g. face grooves) and/or hardware may require a different intumescent seal specification compared to that stated for the leaf configurations in section 4.5. Where this is the case, it is important that the following conditions are met:
  - The intumescent type given for the specific design detail must match that given for the required leaf configuration and leaf size (e.g. if graphite is given as the required seal type for a concealed closer, only leaf configurations and sizes approved for graphite type seals can be used).
  - The largest of the intumescent specifications given for the different design details must take precedence, which is to be determined by the total amount of intumescent required for that design detail (e.g. if the total amount of perimeter intumescent for a particular concealed closer is greater than that required for the associated leaf configuration and size, the intumescent detail stated for the concealed closer would take precedence).

#### 4.5.4.2 Explanation for following sections

The performance of a doorset in terms of configuration and size is dependent on the leaf type, perimeter intumescent used and frame type. These elements are not automatically interchangeable. The following sections present the envelopes for the 6 leaf types and 2 frame types. Each envelope is linked to a specific perimeter intumescent which is given a unique reference and is based directly on test evidence.

The envelopes are presented as follows:

- for LSASD increasing in configuration complexity up to ULSADD+OP/DADD+OP.
- for each configuration, each leaf type is considered separately.
- for each configuration and leaf type, each frame type is considered separately.
- for each configuration, leaf type, frame type and intumescent specification is considered separately, and a unique envelope of permitted leaf sizes is presented based on the configuration, leaf type, frame type and intumescent and the envelope is directly linked to a unique test.

Section 4.5.5.21 specifically details requirements for leaf type 1 LSASD doorsets with multipoint locks.

Sections 4.5.5.22 & 4.5.5.23 specifically detail requirements for leaf types 1 – 6 doorsets utilising the Safehinge Alumax system detailed in section 10.6.1.

## 4.5.5 Data Sheets

### 4.5.5.1 All Leaf Types/Facing Options – LSASD

<b>Intumescent Specification For: LSASD Single Point Lock only</b>			
<b>Intumescent Spec. Ref. (Test Ref)</b>	<b>Type / Make</b>	<b>Manufacturer/ Supplier</b>	<b>Location, Size &amp; Quantity</b>
A1 (RF08116)	Rigid Box Seals	Pyroplex Ltd	Head & Jambs: 1No. 15 x 4mm exposed strip. Fitted centrally in the leaf edge or frame reveal to the head and jambs.
A2 (RF08116)	Rigid Box Seals	Pyroplex Ltd	Head & Jambs: 1No. 20 x 4mm exposed strip. Fitted centrally in the leaf edge or frame reveal to the head and jambs.
A3 (RF00166)	Type 617 or Palusol 100	Lorient Polyproducts Ltd	Head & Jambs: 1No. 15 x 4mm exposed strip. Fitted centrally in the leaf edge or frame reveal to the head and jambs.
A4 (RF00166)	Type 617 or Palusol 100	Lorient Polyproducts Ltd	Head & Jambs: Leaf Size in excess of 2390mm high and/or 1100mm wide 1No. 25 x 4mm exposed strip. Fitted centrally in the leaf edge or frame reveal to the head and jambs.



LSASD  
 (Single Point Lock)  
 All Leaf Types/Facing Options  
 Intumescent specs A1 & A2 have the same leaf size envelope

■ Intu. Spec. - A1    ◆ Intu. Spec. - A2    ● Intu. Spec. - A3    ● Intu. Spec. - A4



#### 4.5.5.2 All Leaf Type/Facing Options – ULSASD & DASD

<b>Intumescent Specification For: ULSASD &amp; DASD</b>			
<b>Single Point Lock only</b>			
<b>Intumescent Spec. Ref.</b> (Test Ref)	<b>Type / Make</b>	<b>Manufacturer/ Supplier</b>	<b>Location, Size &amp; Quantity</b>
B1 (RF08116)	Rigid Box Seals	Pyroplex Ltd	Head & Jambs: 1No. 15 x 4mm exposed strip. Fitted centrally in the leaf edge or frame reveal to the head and jambs.
B2 (RF08116)	Rigid Box Seals	Pyroplex Ltd	Head & Jambs: 1No. 20 x 4mm exposed strip. Fitted centrally in the leaf edge or frame reveal to the head and jambs.
B3 (RF00166)	Type 617 or Palusol 100	Lorient Polyproducts Ltd	Head & Jambs: Leaf Size in excess of 2390mm high and/or 1100mm wide 1No. 25 x 4mm exposed strip. Fitted centrally in the leaf edge or frame reveal to the head and jambs.

ULSASD & DASD  
(Single Point Lock)  
All Leaf Types/Facing Options  
Intumescent specs B1 & B2 have the same leaf size envelope

■ Intum. Spec. - B1    ◆ Intum. Spec. - B2    ● Intum. Spec. - B3

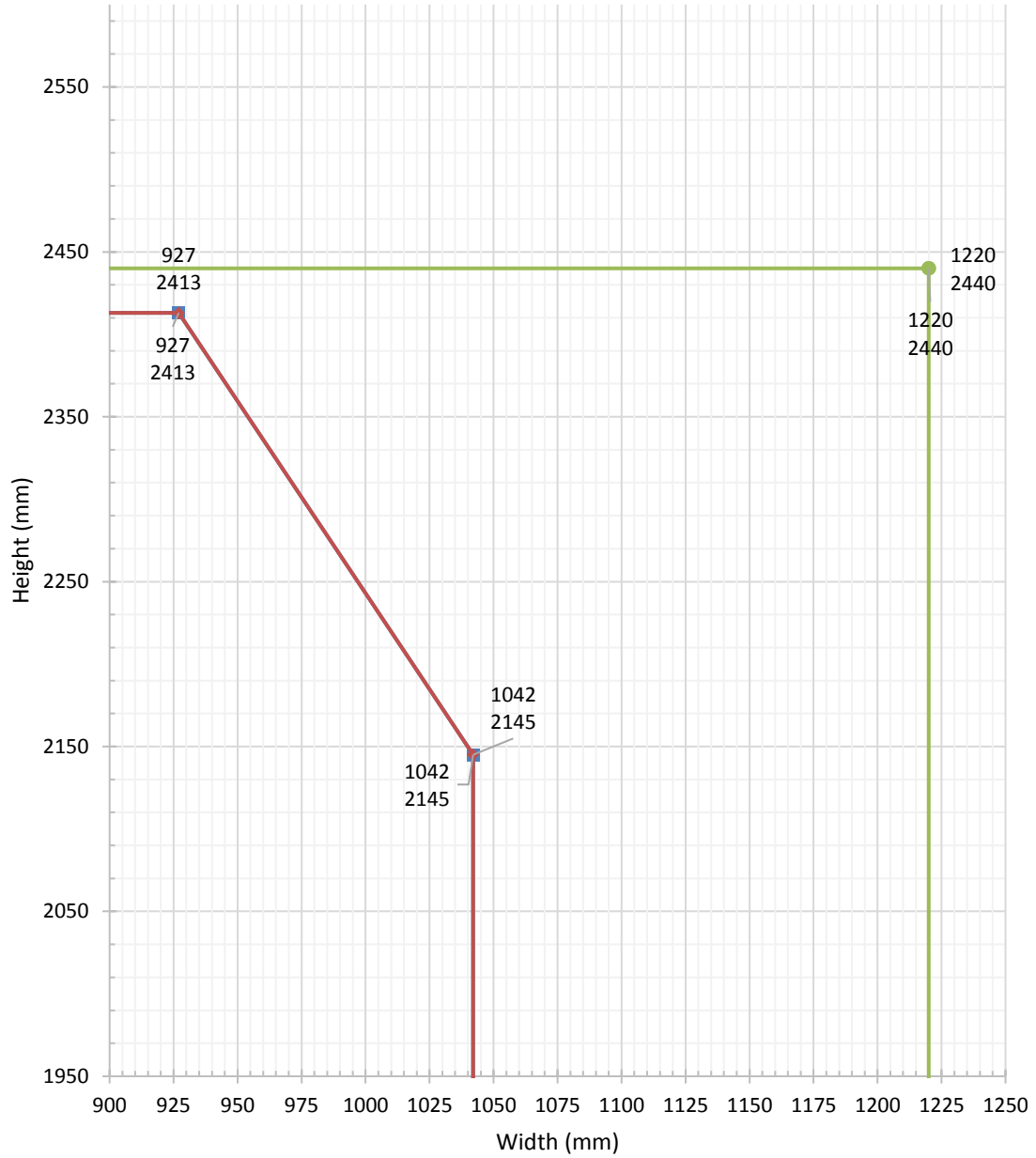

### 4.5.5.3 All Leaf Type/Facing Options – LSADD

<b>Intumescent Specification For: LSADD Single Point Lock only</b>			
<b>Intumescent Spec. Ref. (Test Ref)</b>	<b>Type / Make</b>	<b>Manufacturer/ Supplier</b>	<b>Location, Size &amp; Quantity</b>
C1 (RF08116)	Rigid Box Seals	Pyroplex Ltd	Head & Hanging Jambes: 1No. 15 x 4mm exposed strip. Fitted centrally in the leaf edge or frame reveal to the head and jambes. Meeting Edges: Square: 2No 10 x mm seals fitted 5mm either side of centreline in one leaf edge only
C2 (RF98033)	Type 617 or Palusol 100	Lorient Polyproducts Ltd	Head & Hanging Jambes: 1No. 20 x 4mm exposed strip. Fitted centrally in the leaf edge or frame reveal to the head and jambes. Meeting Edges: Square: 1No 20 x mm seals fitted centrally in one leaf edge only. Meeting Edges: Rebated: 1No. 10 x 4mm seal fitted centrally in the rebate of both leaf edges.
C3 (RF98033)	Type 617 or Palusol 100	Lorient Polyproducts Ltd	Head & Hanging Jambes: 1No. 25 x 4mm exposed strip. Fitted centrally in the leaf edge or frame reveal to the head and jambes. Meeting Edges: Square: 1No 20 x mm seals fitted centrally in one leaf edge only. Meeting Edges: Rebated: 1No. 10 x 4mm seal fitted centrally in the rebate of both leaf edges.

LSADD  
(Single Point Lock)  
All Leaf Types/Facing Options  
Intumescent specs C2 & C3 have the same leaf size envelope

■ Intum. Spec. - C1    ◆ Intum. Spec. - C2    ● Intum. Spec. - C3

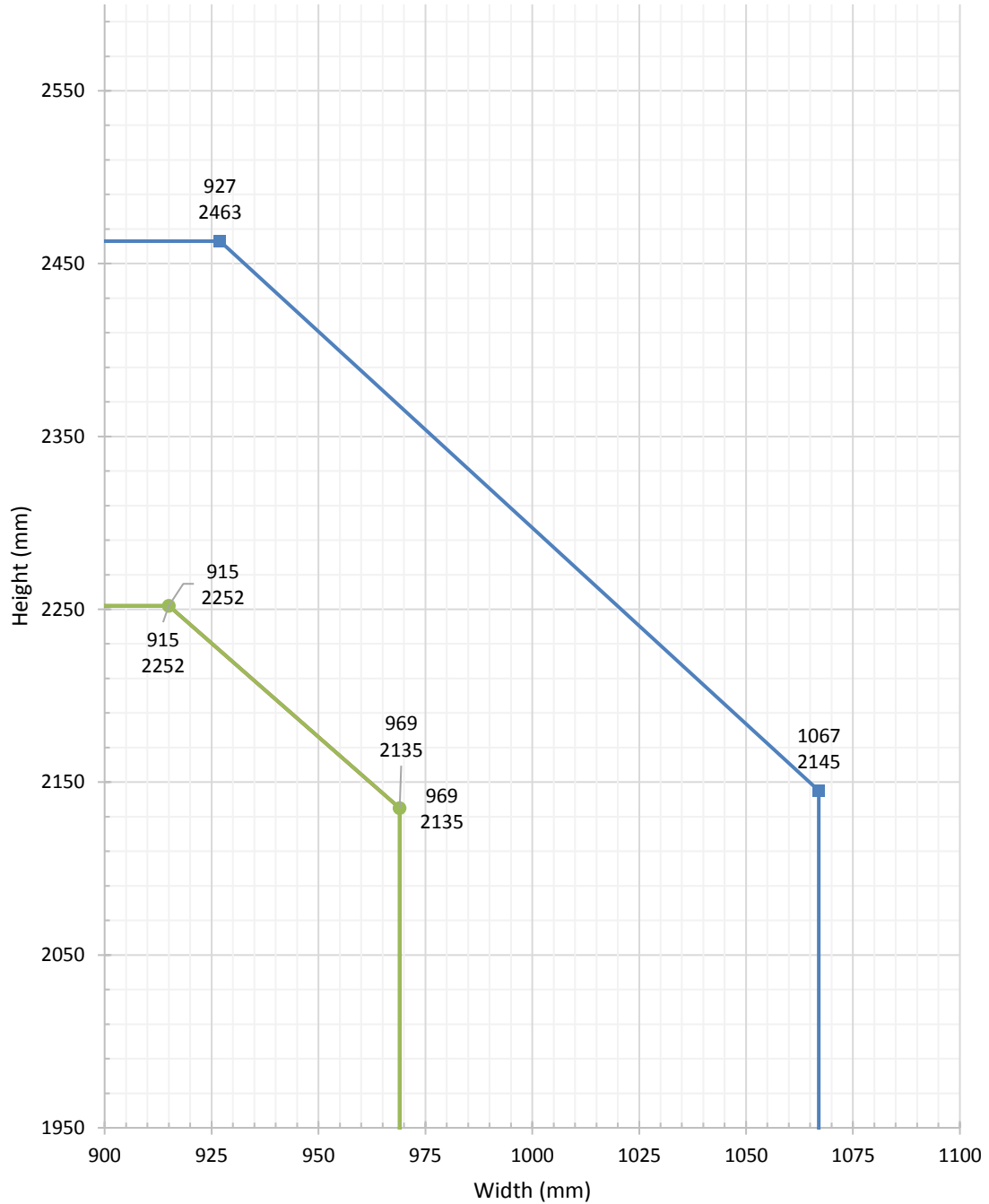

#### 4.5.5.4 All Leaf Type/Facing Options – ULSADD & DADD

<b>Intumescent Specification For: ULSADD &amp; DADD</b>			
<b>Single Point Lock only</b>			
<b>Intumescent Spec. Ref.</b> (Test Ref)	<b>Type / Make</b>	<b>Manufacturer/ Supplier</b>	<b>Location, Size &amp; Quantity</b>
D1 (RF08116)	Rigid Box Seals	Pyroplex Ltd	<p>Head &amp; Hanging Jambs:            1No. 15 x 4mm exposed strip.            Fitted centrally in the leaf edge or frame reveal to the head and jambs.</p> <p>Meeting Edges: Square:            2No 10 x mm seals fitted 5mm either side of centreline in one leaf edge only</p>
D2 (RF98033)	Type 617 or Palusol 100	Lorient Polyproducts Ltd	<p>Head &amp; Hanging Jambs:            1No. 20 x 4mm exposed strip.            Fitted centrally in the leaf edge or frame reveal to the head and jambs.</p> <p>Meeting Edges: Square:            1No 20 x mm seals fitted centrally in one leaf edge only.</p> <p>Meeting Edges: Rebated:            1No. 10 x 4mm seal fitted centrally in the rebate of both leaf edges.</p>

ULSADD & DADD  
(Single Point Lock)  
All Leaf Types/Facing Options

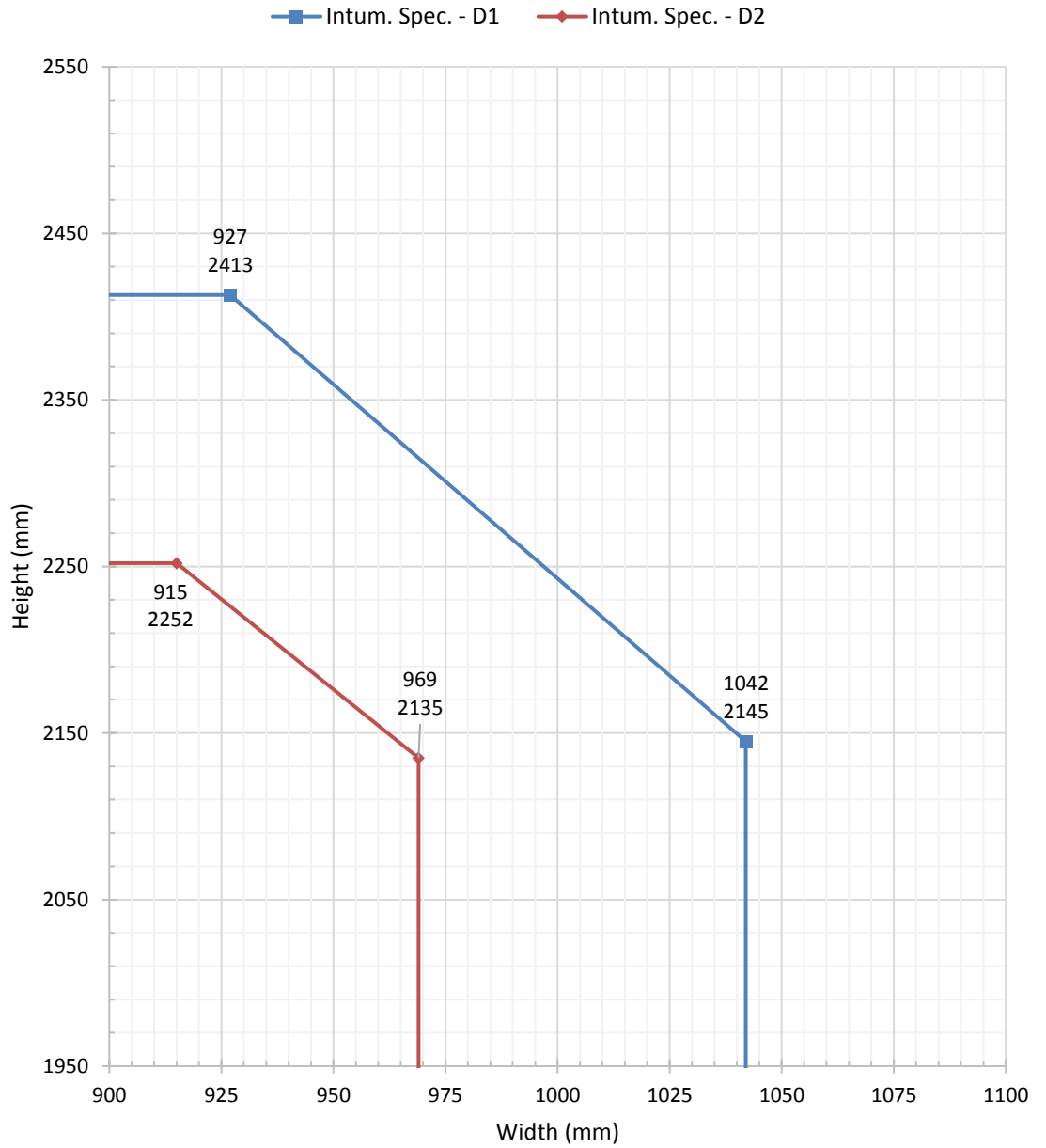

#### 4.5.5.5 4mm Thick Plywood (Leaf Type 1) Facings – LSASD

<b>Intumescent Specification For: LSASD &amp; Single Point Lock</b>			
<b>Intumescent Spec. Ref.</b>	<b>Type / Make</b>	<b>Manufacturer/ Supplier</b>	<b>Location, Size &amp; Quantity</b>
E1 (RF08116)	Rigid Box Seals	Pyroplex Ltd	Head & Jambs: 1No. 10 x 4mm exposed strip. Fitted centrally in the leaf edge or frame reveal to the head and jambs.
E2 (RF00166)	Type 617 or Palusol 100	Lorient Polyproducts Ltd	Head & Jambs: 1No. 15 x 4mm exposed strip. Fitted centrally in the leaf edge or frame reveal to the head and jambs.
E3 (RF00166)	Type 617 or Palusol 100	Lorient Polyproducts Ltd	Head & Jambs: 1No. 20 x 4mm exposed strip. Fitted centrally in the leaf edge or frame reveal to the head and jambs.
E4 (RF00166)	Type 617 or Palusol 100	Lorient Polyproducts Ltd	Head & Jambs: Leaf Size in excess of 2390mm high and/or 1100mm wide 1No. 25 x 4mm exposed strip. Fitted centrally in the leaf edge or frame reveal to the head and jambs.
E5 (WF381914)	ST154FO	Sealed Tight Solutions Ltd	Head & Jambs: 1No. 15 x 4mm exposed strip. Fitted centrally in the leaf edge or frame reveal to the head and jambs.
E6 (WF381914)	ST204FO	Sealed Tight Solutions Ltd	Head & Jambs: Leaf Size in excess of 2600mm high and/or 1250mm wide 1No. 20 x 4mm exposed strip. Fitted centrally in the leaf edge or frame reveal to the head and jambs.



LSASD  
 (Single Point Lock)  
 4 Plywood Facings Leaf Type 1  
 Intumescent specs E2 & E3 have the same leaf size envelopes

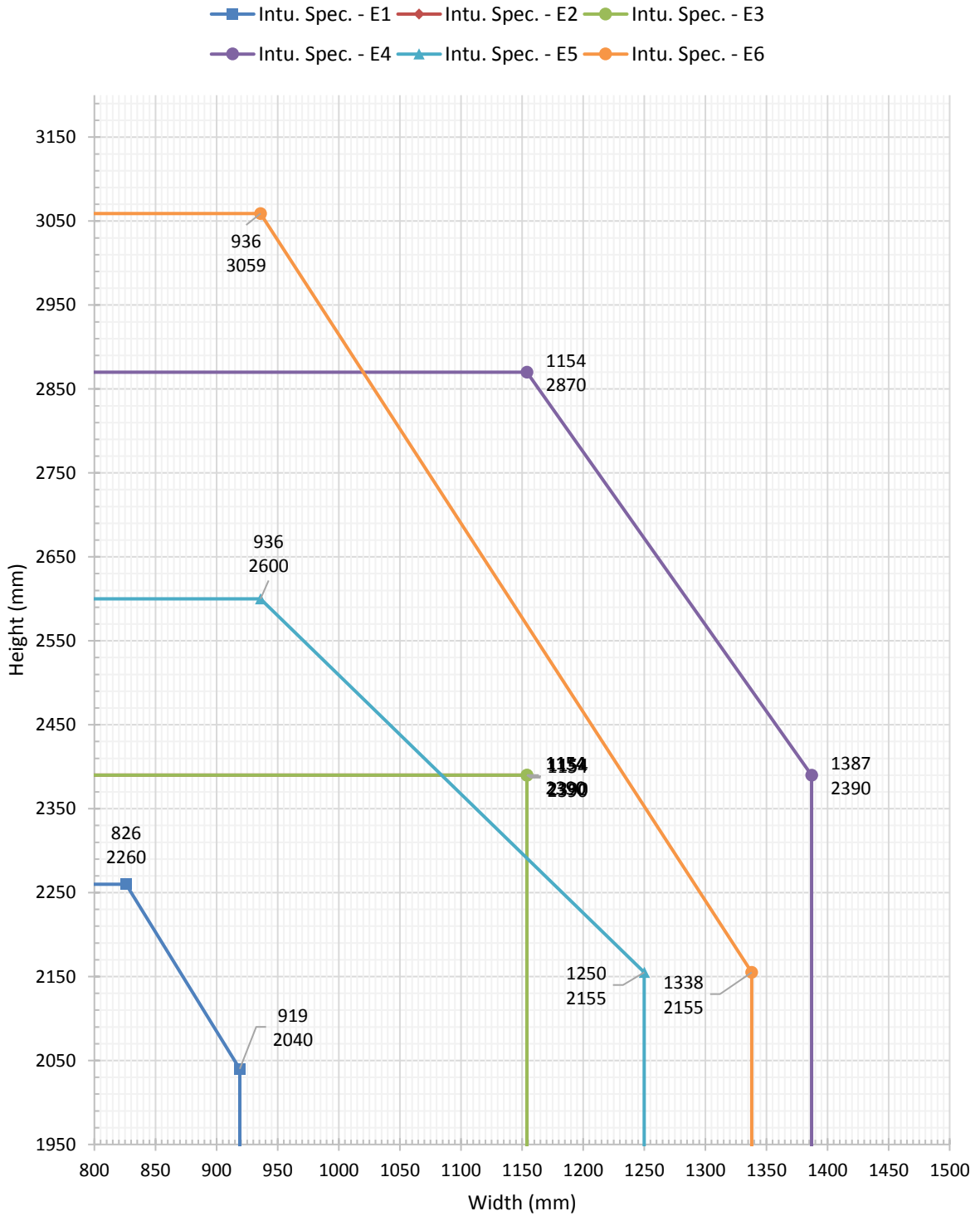

#### 4.5.5.6 4mm Thick Plywood (Leaf Type 1) Facings – ULSASD & DASD

<b>Intumescent Specification For: ULSASD &amp; DASD Single Point Lock</b>			
<b>Intumescent Spec. Ref.</b>	<b>Type / Make</b>	<b>Manufacturer/ Supplier</b>	<b>Location, Size &amp; Quantity</b>
F1 (RF08116)	Rigid Box Seals	Pyroplex Ltd	Head & Jambs: 1No. 10 x 4mm exposed strip. Fitted centrally in the leaf edge or frame reveal to the head and jambs.
F2 (RF08116)	Rigid Box Seals	Pyroplex Ltd	Head & Jambs: 1No. 15 x 4mm exposed strip. Fitted centrally in the leaf edge or frame reveal to the head and jambs.
F3 (RF00166)	Type 617 or Palusol 100	Lorient Polyproducts Ltd	Head & Jambs: 1No. 15 x 4mm exposed strip. Fitted centrally in the leaf edge or frame reveal to the head and jambs.
F4 (RF00166)	Type 617 or Palusol 100	Lorient Polyproducts Ltd	Head & Jambs: 1No. 20 x 4mm exposed strip. Fitted centrally in the leaf edge or frame reveal to the head and jambs.
F5 (RF00166)	Type 617 or Palusol 100	Lorient Polyproducts Ltd	Head & Jambs: Leaf Size in excess of 2390mm high and/or 1100mm wide 1No. 25 x 4mm exposed strip. Fitted centrally in the leaf edge or frame reveal to the head and jambs.
F6 (WF381914)	ST154FO	Sealed Tight Solutions Ltd	Head & Jambs: 1No. 15 x 4mm exposed strip. Fitted centrally in the leaf edge or frame reveal to the head and jambs.
F7 (WF381914)	ST204FO	Sealed Tight Solutions Ltd	Head & Jambs: Leaf Size in excess of 2600mm high and/or 1250mm wide 1No. 20 x 4mm exposed strip. Fitted centrally in the leaf edge or frame reveal to the head and jambs.

ULSASD & DASD  
 (Single Point Lock)  
 4 Plywood Facings Leaf Type 1  
 Intumescent specs F1 & F2; F3 & F4 and F6 & F7 have the same leaf size envelopes

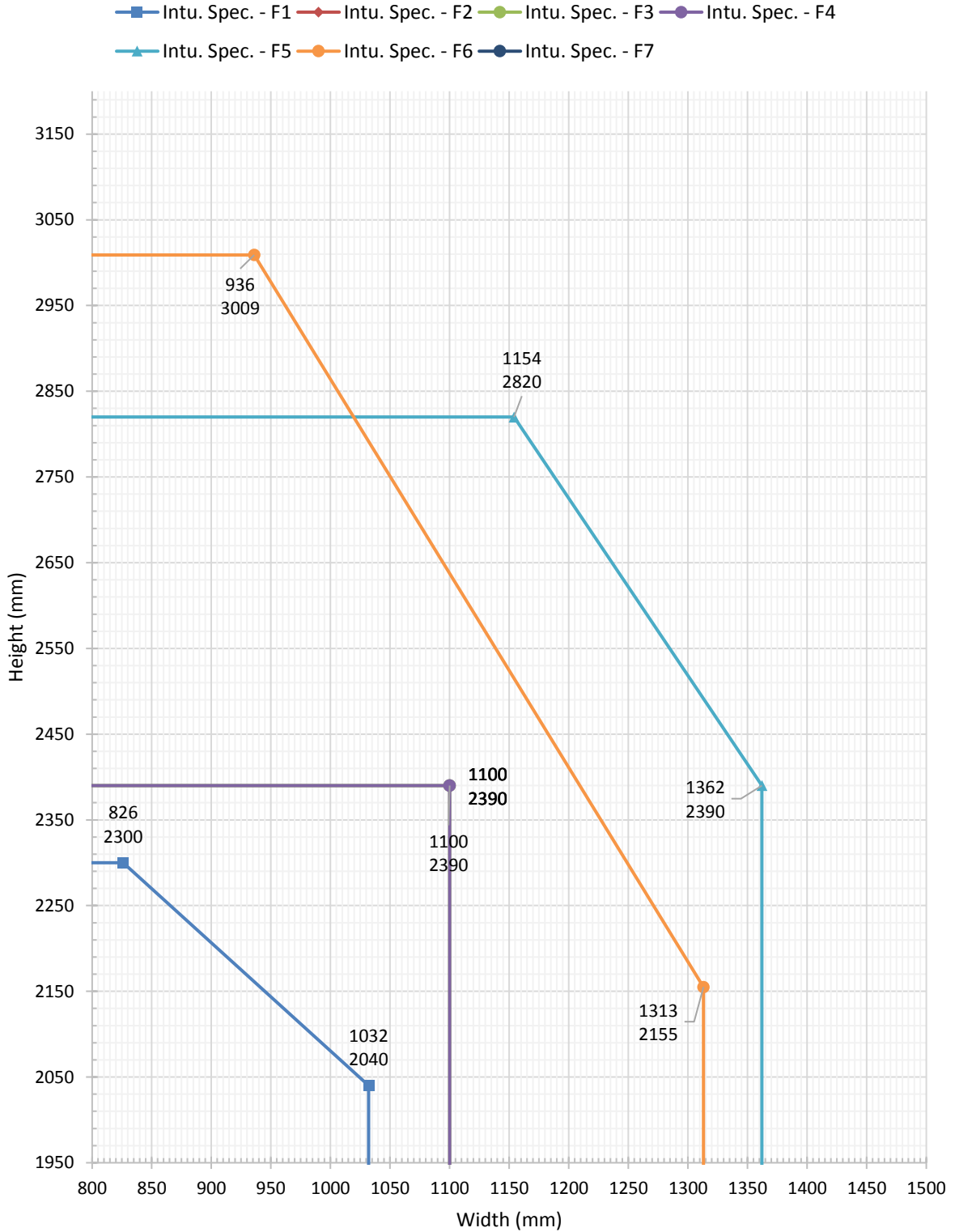

#### 4.5.5.7 4mm Thick Plywood (Leaf Type 1) Facings – LSADD

<b>Intumescent Specification For: LSADD Single Point Lock</b>			
<b>Intumescent Spec. Ref. (Test Ref)</b>	<b>Type / Make</b>	<b>Manufacturer/ Supplier</b>	<b>Location, Size &amp; Quantity</b>
G1 (RF98033)	Type 617 or Palusol 100	Lorient Polyproducts Ltd	Head & Hanging Jambs: 1No. 20 x 4mm exposed strip. Fitted centrally in the leaf edge or frame reveal to the head and jambs. Meeting Edges: Square: 1No 20 x mm seals fitted centrally in one leaf edge only. Meeting Edges: Rebated: 1No. 10 x 4mm seal fitted centrally in the rebate of both leaf edges.
G2 (RF98033)	Type 617 or Palusol 100	Lorient Polyproducts Ltd	Head & Hanging Jambs: 1No. 25 x 4mm exposed strip. Fitted centrally in the leaf edge or frame reveal to the head and jambs. Meeting Edges: Square: 1No 20 x mm seals fitted centrally in one leaf edge only. Meeting Edges: Rebated: 1No. 10 x 4mm seal fitted centrally in the rebate of both leaf edges.
G3 (WF381914)	ST104FO & ST154FO	Sealed Tight Solutions Ltd	Head & Hanging Jambs: 1No. 15 x 4mm exposed strip. Fitted centrally in the leaf edge or frame reveal to the head and jambs. Meeting Edges: Square: 2No 10 x 4mm seals fitted centrally 10mm apart in one leaf edge only
G4 (WF381914)	ST104FO & ST154FO	Sealed Tight Solutions Ltd	Head & Hanging Jambs: Leaf Size in excess of 2600mm high and/or 1250mm wide 1No. 20 x 4mm exposed strip. Fitted centrally in the leaf edge or frame reveal to the head and jambs. Meeting Edges: Square: 2No 15 x 4mm seals fitted centrally 5mm apart in one leaf edge only

LSADD  
(Single Point Lock)  
4 Plywood Facings Leaf Type 1  
Intumescent specs G1 & G2 have the same leaf size envelope



#### 4.5.5.8 4mm Thick Plywood (Leaf Type 1) Facings – ULSADD & DADD

<b>Intumescent Specification For: ULSADD &amp; DADD Single Point Lock</b>			
<b>Intumescent Spec. Ref.</b>	<b>Type / Make</b>	<b>Manufacturer/ Supplier</b>	<b>Location, Size &amp; Quantity</b>
H1 (RF98033)	Type 617 or Palusol 100	Lorient Polyproducts Ltd	<p>Head &amp; Hanging Jambs: 1No. 20 x 4mm exposed strip. Fitted centrally in the leaf edge or frame reveal to the head and jambs.</p> <p>Meeting Edges: Square: 1No 20 x mm seals fitted centrally in one leaf edge only.</p> <p>Meeting Edges: Rebated: 1No. 10 x 4mm seal fitted centrally in the rebate of both leaf edges.</p>
H2 (RF98033)	Type 617 or Palusol 100	Lorient Polyproducts Ltd	<p>Head &amp; Hanging Jambs: 1No. 25 x 4mm exposed strip. Fitted centrally in the leaf edge or frame reveal to the head and jambs.</p> <p>Meeting Edges: Square: 1No 20 x 4mm seals fitted centrally in one leaf edge only.</p> <p>Meeting Edges: Rebated: 1No. 10 x 4mm seal fitted centrally in the rebate of both leaf edges.</p>
H3 (WF381914)	ST104FO & ST154FO	Sealed Tight Solutions Ltd	<p>Head &amp; Hanging Jambs: 1No. 15 x 4mm exposed strip. Fitted centrally in the leaf edge or frame reveal to the head and jambs.</p> <p>Meeting Edges: Square: 2No 10 x 4mm seals fitted centrally 10mm apart in one leaf edge only</p>
H4 WF381914)	ST104FO & ST154FO	Sealed Tight Solutions Ltd	<p>Head &amp; Hanging Jambs: Leaf Size in excess of 2600mm high and/or 1250mm wide 1No. 20 x 4mm exposed strip. Fitted centrally in the leaf edge or frame reveal to the head and jambs.</p> <p>Meeting Edges: Square: 2No 15 x 4mm seals fitted centrally 5mm apart in one leaf edge only</p>

ULSADD & DADD  
(Single Point Lock)  
4 Plywood Facings Leaf Type 1  
Intumescent specs H1 & H2 have the same leaf size envelope

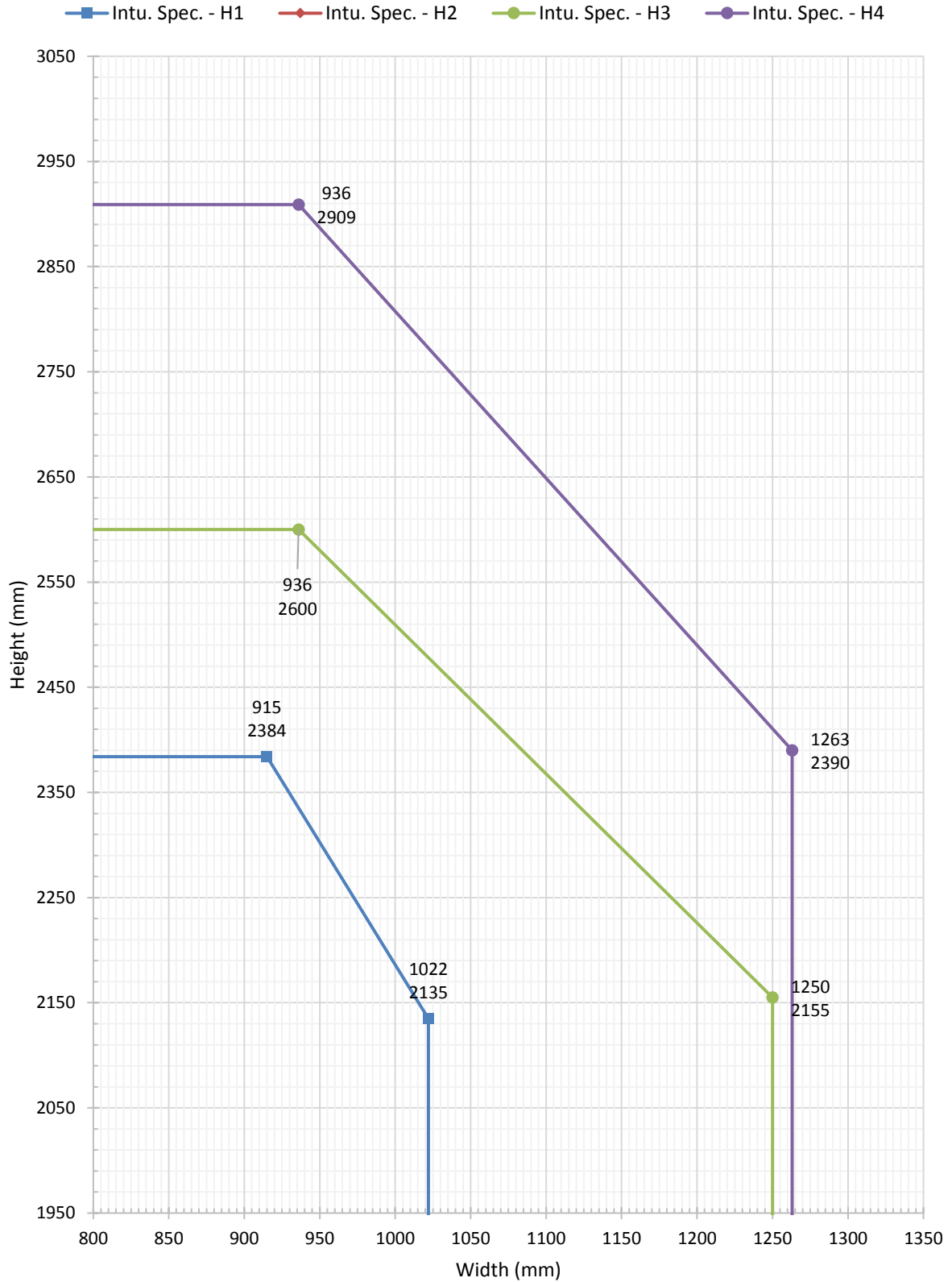

#### 4.5.5.9 4mm Thick Plywood (Leaf Type 1) Facings – LSASD+OP

Intumescent Specification For: LSASD+OP Single Point Lock			
Intumescent Spec. Ref.	Type / Make	Manufacturer/ Supplier	Location, Size & Quantity
I1 (RF08118)	Rigid Box Seals	Pyroplex Ltd	<p><b>Head: Square:</b>                      2No. 10 x 4mm PVC encapsulated Pyroplex fitted centrally 10mm apart in the leaf edge or bottom of overpanel.</p> <p><b>Head: Rebated:</b>  <b>Head of Leaves:</b> 2No. 10 x 4mm with one strip centrally fitted on the top of the upstand of the rebate and one centrally in the bottom of the rebate.</p> <p><b>Jams:</b> 2No. 10 x 4mm fitted centrally in the leaf edge or frame reveal.</p>



LSASD+OP  
(Single Point Lock)  
4 Plywood Facings Leaf Type 1  
—■— Intu. Spec. - I1

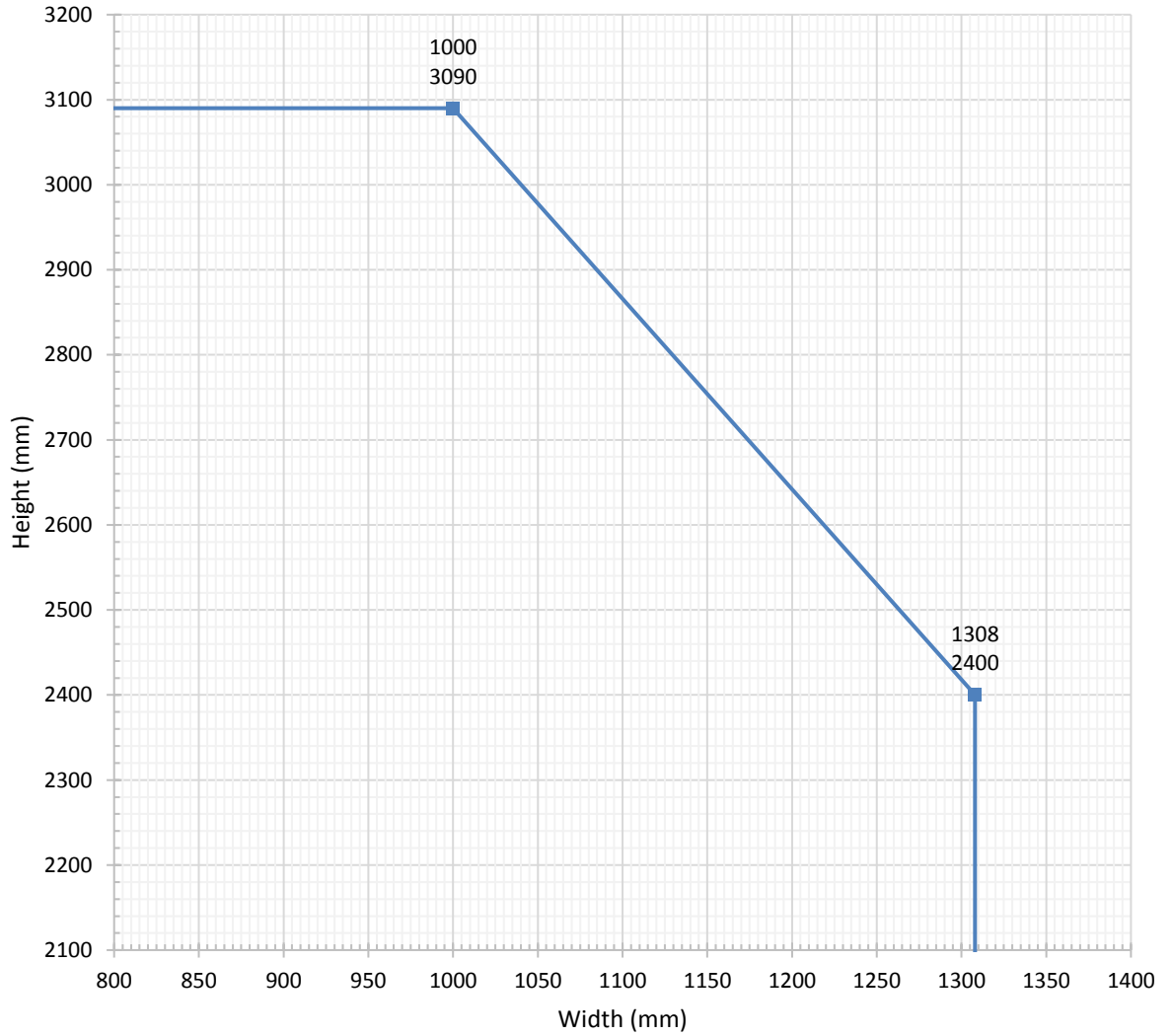

#### 4.5.5.10 4mm Thick Plywood (Leaf Type 1) Facings – ULSASD+OP & DASD+OP

Intumescent Specification For: ULSASD+OP & DASD+OP Single Point Lock			
Intumescent Spec. Ref.	Type / Make	Manufacturer/ Supplier	Location, Size & Quantity
J1 (RF08118)	Rigid Box Seals	Pyroplex Ltd	<p><b>Head: Square:</b>                      2No. 10 x 4mm PVC encapsulated Pyroplex fitted centrally 10mm apart in the leaf edge or bottom of overpanel.</p> <p><b>Head: Rebated:</b>  <b>Head of Leaves:</b> 2No. 10 x 4mm with one strip centrally fitted on the top of the upstand of the rebate and one centrally in the bottom of the rebate.</p> <p><b>Jamb:</b> 2No. 10 x 4mm fitted centrally in the leaf edge or frame reveal.</p>

ULSASD+OP & DASD+OP  
 (Single Point Lock)  
 4 Plywood Facings Leaf Type 1

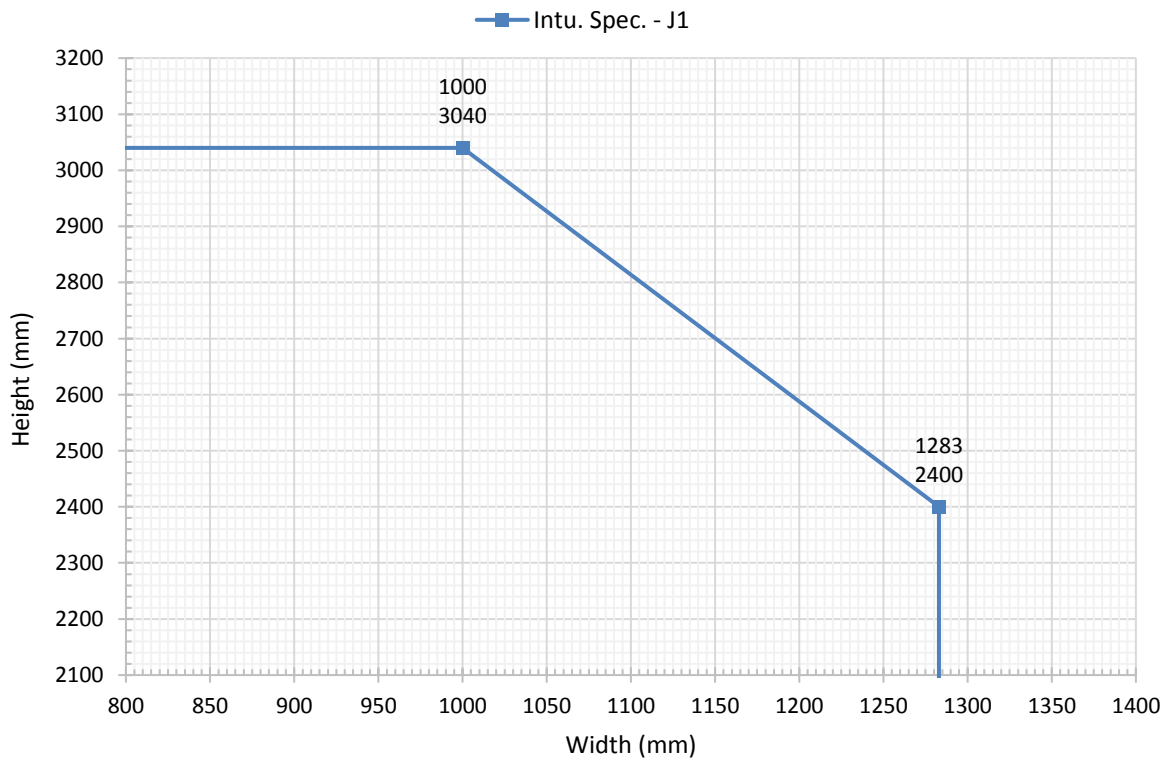

#### 4.5.5.11 4mm Thick Plywood (Leaf Type 1) Facings – LSADD+OP

Intumescent Specification For: LSADD+OP Single Point Lock			
Intumescent Spec. Ref.	Type / Make	Manufacturer/ Supplier	Location, Size & Quantity
K1 (RF08118)	Rigid Box Seals	Pyroplex Ltd	<p><b>Head: Square:</b>                      2No. 10 x 4mm PVC encapsulated Pyroplex fitted centrally 10mm apart in the leaf edge or bottom of overpanel.</p> <p><b>Head: Rebated:</b>  <b>Head of Leaves:</b> 2No. 10 x 4mm with one strip centrally fitted on the top of the upstand of the rebate and one centrally in the bottom of the rebate.</p> <p><b>Jamb:</b> 2No. 10 x 4mm fitted centrally in the leaf edge or frame reveal.</p> <p><b>Meeting Edges:</b> 2No. 10 x 4mm fitted centrally 10mm apart in one leaf edge only.</p>

LSADD+OP  
 (Single Point Lock)  
 4 Plywood Facings Leaf Type 1

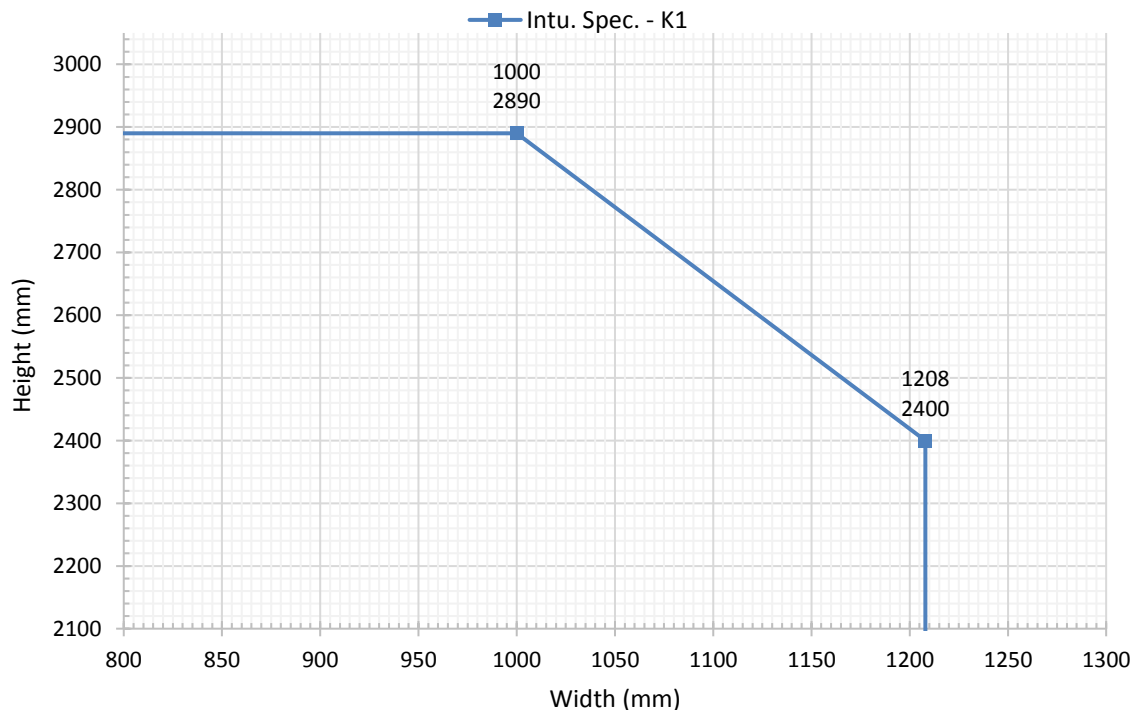

#### 4.5.5.12 4mm Thick Plywood (Leaf Type 1) Facings – ULSADD+OP & DADD+OP

Intumescent Specification For: ULSADD+OP & DADD+OP Single Point Lock			
Intumescent Spec. Ref.	Type / Make	Manufacturer/ Supplier	Location, Size & Quantity
L1 (RF08118)	Rigid Box Seals	Pyroplex Ltd	<p><b>Head: Square:</b>                      2No. 10 x 4mm PVC encapsulated Pyroplex fitted centrally 10mm apart in the leaf edge or bottom of overpanel.</p> <p><b>Head: Rebated:</b>  <b>Head of Leaves:</b> 2No. 10 x 4mm with one strip centrally fitted on the top of the upstand of the rebate and one centrally in the bottom of the rebate.</p> <p><b>Jams:</b> 2No. 10 x 4mm fitted centrally in the leaf edge or frame reveal.</p> <p><b>Meeting Edges:</b> 2No. 10 x 4mm fitted centrally 10mm apart in one leaf edge only.</p>

ULSADD+OP & DADD+OP  
 (Single Point Lock)  
 4 Plywood Facings Leaf Type 1

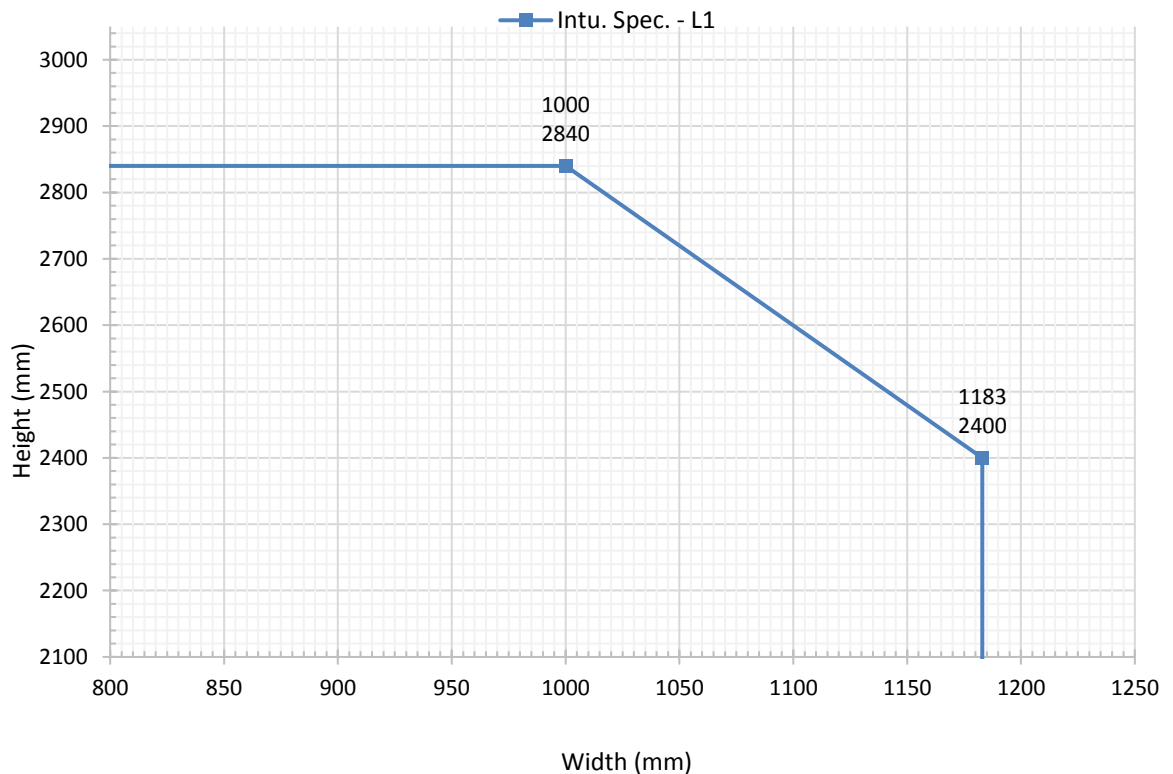

#### 4.5.5.13 4mm & 6mm thick Plywood and 6mm thick MDF Leaf Facings (Leaf Types 1, 2 and 5) – LSASD

Intumescent Specification For: LSASD (Leaf Types 1, 2 and 5) Single Point Lock			
Intumescent Spec. Ref. (Test Ref)	Type / Make	Manufacturer / Supplier	Location, Size & Quantity
M1 (RF08118)	Rigid Box Seals	Pyroplex Ltd	Head & Jambes: 2No. 10 x 4mm exposed strip. Fitted centrally in the leaf edge or frame reveal to the head and jamb.

LSASD (Single Point Lock)  
(Leaf Types 1, 2 and 5)

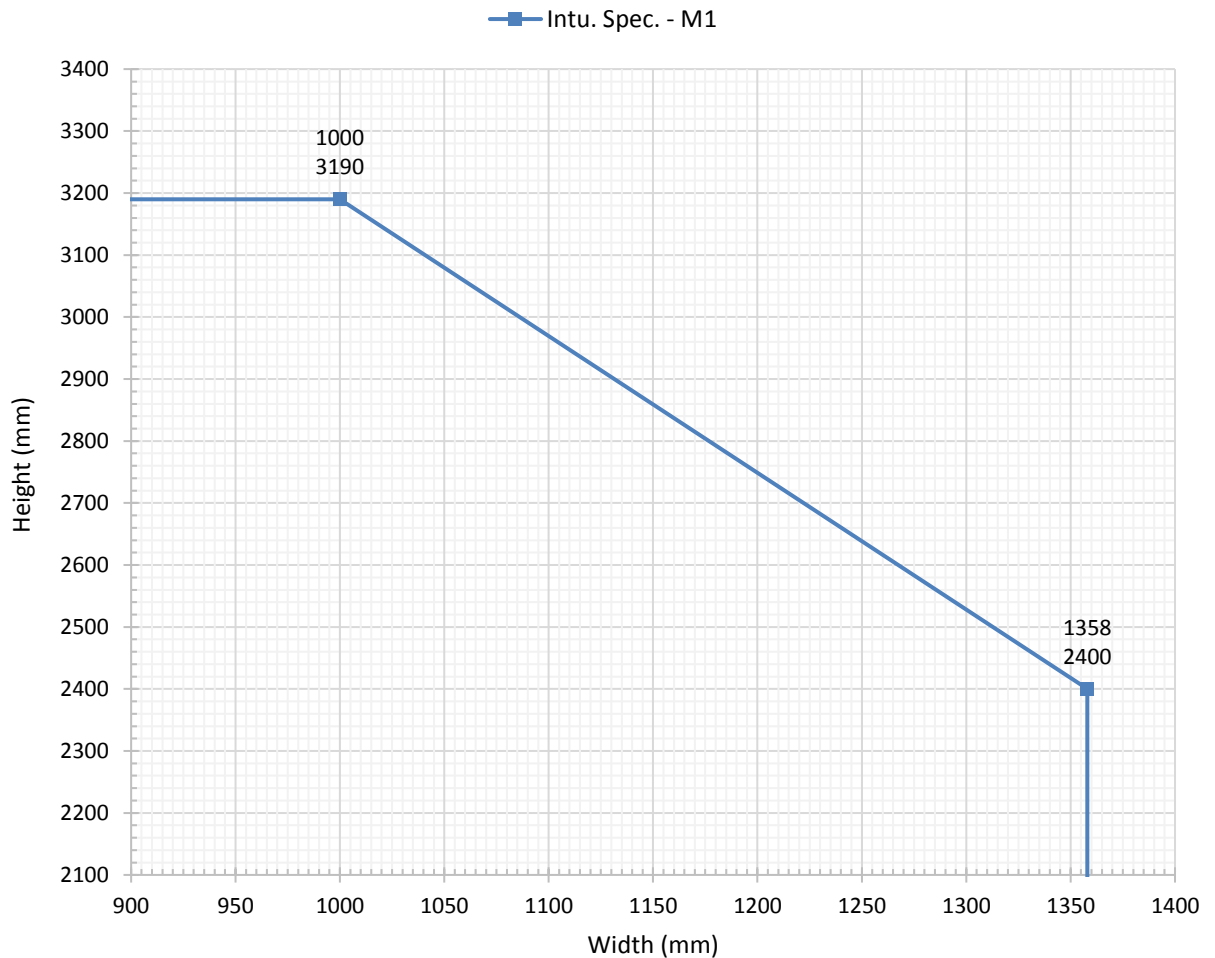

**4.5.5.14 4mm & 6mm thick Plywood and 6mm thick MDF Leaf Facings (Leaf Types 1, 2 and 5)– ULSASD & DASD**

Intumescent Specification For: ULSASD & DASD (Leaf Types 1, 2 and 5) Single Point Lock			
Intumescent Spec. Ref.	Type / Make	Manufacturer/ Supplier	Location, Size & Quantity
N1 (RF08118)	Rigid Box Seals	Pyroplex Ltd	Head & Jambs: 2No. 10 x 4mm exposed strip. Fitted centrally in the leaf edge or frame reveal to the head and jambs.

ULSASD & DASD  
 (Single Point Lock)  
 (Leaf Types 1, 2 and 5)

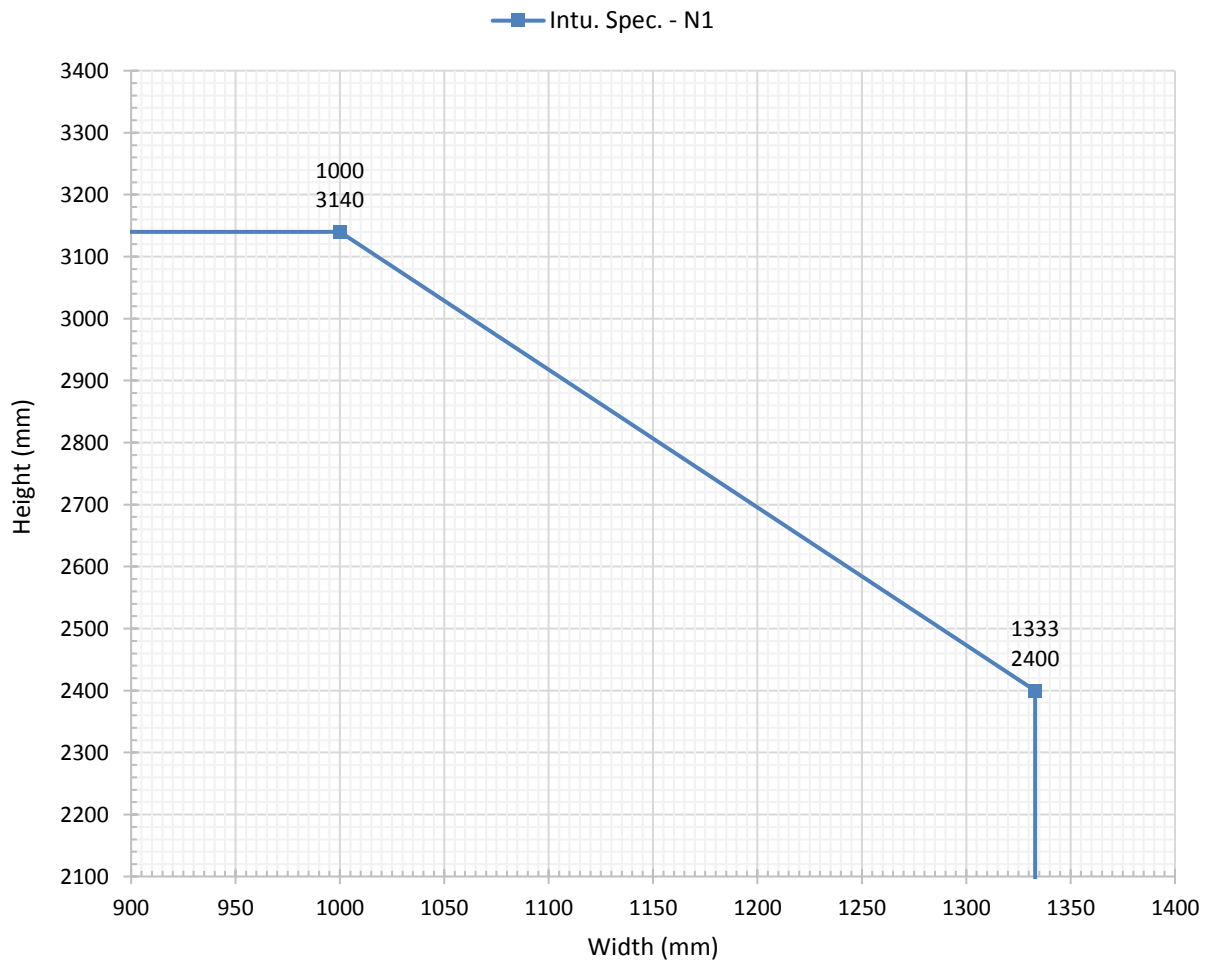

**4.5.5.15 4mm & 6mm thick Plywood and 6mm thick MDF Leaf Facings (Leaf Types 1, 2 and 5) – LSADD**

Intumescent Specification For: LSADD (Leaf Types 1, 2 and 5) Single Point Lock			
Intumescent Spec. Ref.	Type / Make	Manufacturer / Supplier	Location, Size & Quantity
P1 (RF08118)	Rigid Box Seals	Pyroplex Ltd	Head & Hanging Jambs: 2No. 10 x 4mm exposed strip. Fitted centrally 10mm apart in the leaf edge or frame reveal to the head and jambs. Meeting Edges: Square: 2No 10 x 4mm seals fitted centrally 10mm apart in one leaf edge only

LSADD  
 (Single Point Lock)  
 (Leaf Types 1, 2 and 5)

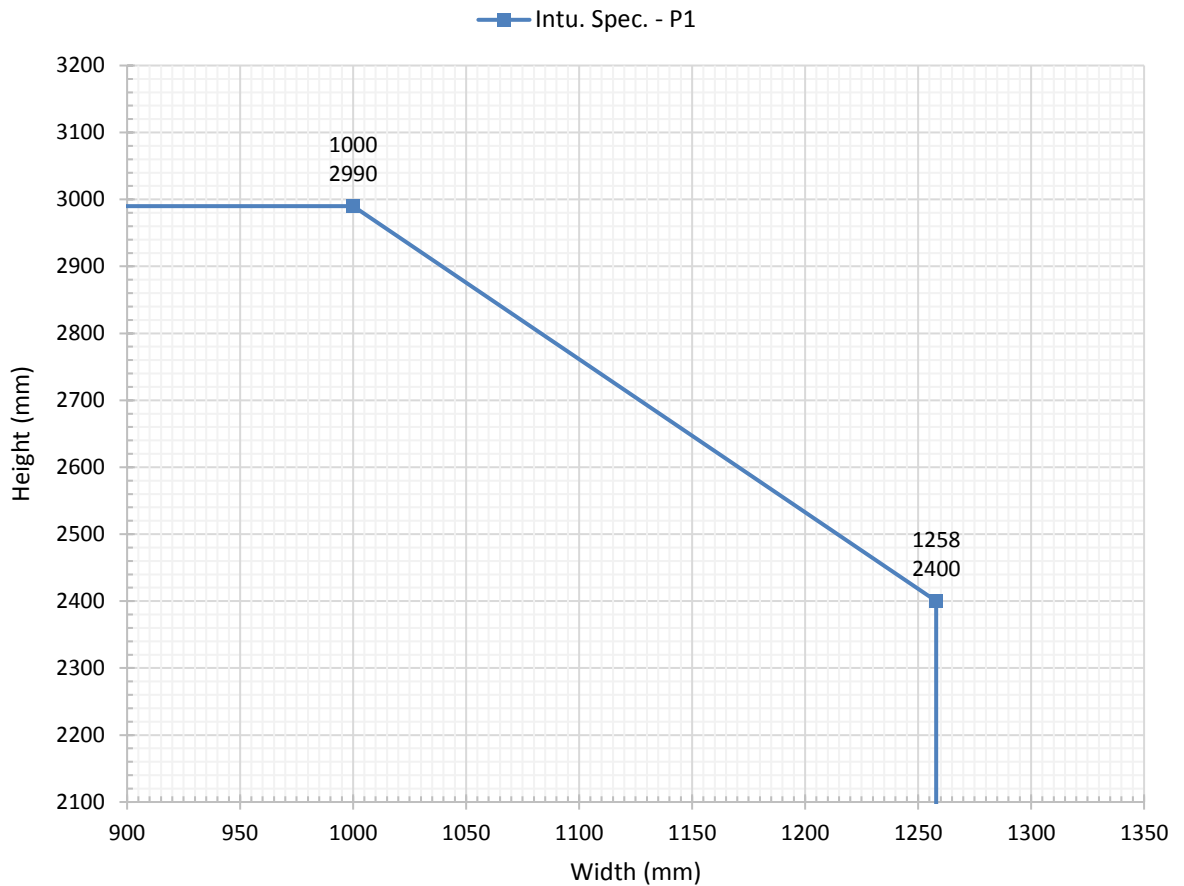

**4.5.5.16 4mm & 6mm Thick Plywood and 6mm thick MDF Leaf Facings (Leaf Types 1, 2 and 5)–ULSADD & DADD**

Intumescent Specification For: ULSADD & DADD (Leaf Types 1, 2 and 5) Single Point Lock			
Intumescent Spec. Ref.	Type / Make	Manufacturer/ Supplier	Location, Size & Quantity
Q1 (RF08118)	Rigid Box Seals	Pyroplex Ltd	Head & Hanging Jambs: 2No. 10 x 4mm exposed strip. Fitted centrally 10mm apart in the leaf edge or frame reveal to the head and jambs. Meeting Edges: Square: 2No 10 x 4mm seals fitted centrally 10mm apart in one leaf edge only

ULSADD & DADD  
 (Single Point Lock)  
 (Leaf Types 1, 2 and 5)

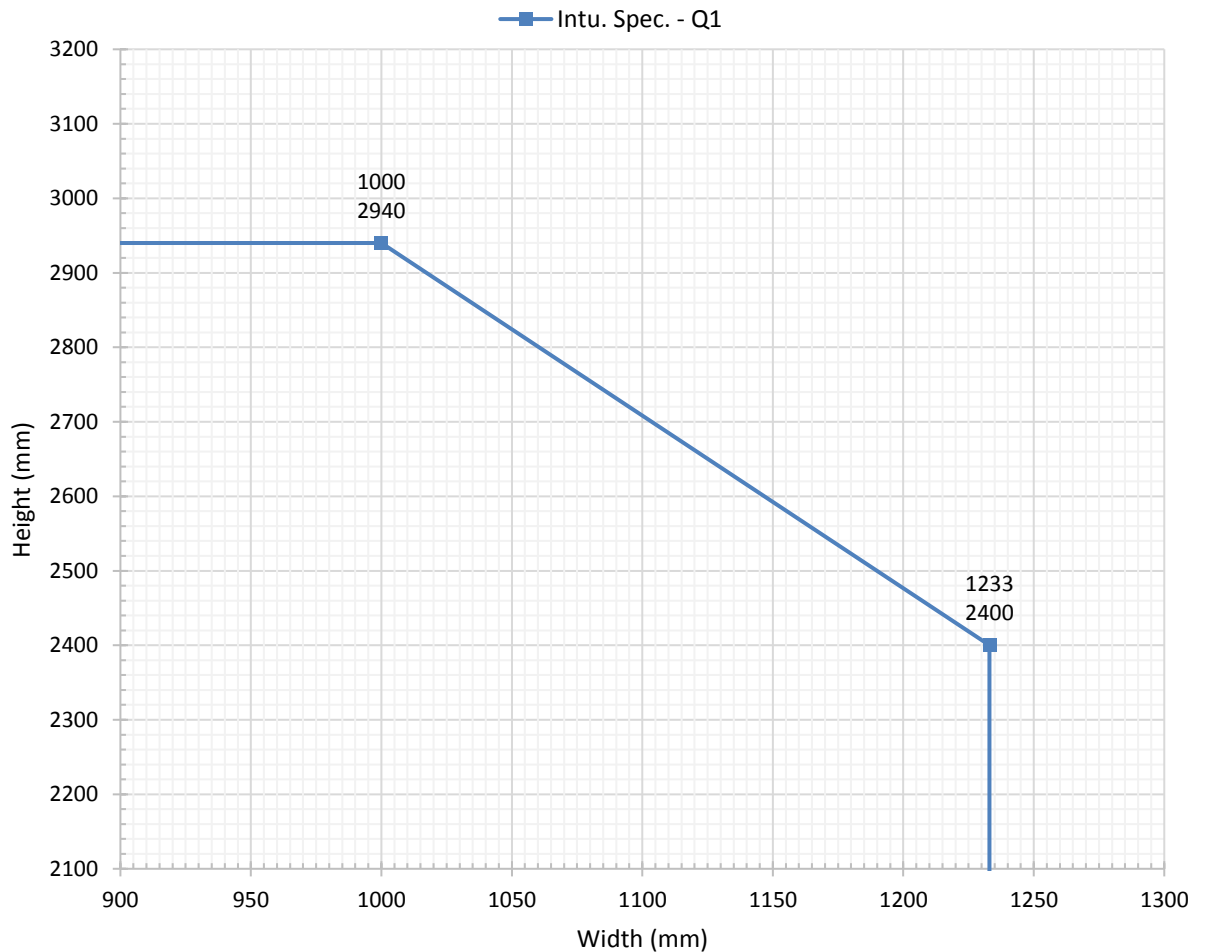



#### 4.5.5.17 6mm thick MDF (Leaf Type 5) Facings – LSASD

Intumescent Specification for LSASD Single Point Lock			
Intumescent Spec. Ref.	Type / Make	Manufacturer / Supplier	Location, Size & Quantity
R1 (RF08116)	Rigid Box Seals	Pyroplex Ltd	Head & Jambs: 1No. 10 x 4mm exposed strip. Fitted centrally in the leaf edge or frame reveal to the head and jambs.
R2 (RF08116)	Rigid Box Seals	Pyroplex Ltd	Head & Jambs: Leaf Size in excess of 2300mm high. 1No. 15 x 4mm exposed strip. Fitted centrally in the leaf edge or frame reveal to the head and jambs.

LSASD  
 (Single Point Lock)  
 Leaf Type 5

Intumescent specs R1 & R2 have the same leaf size envelope

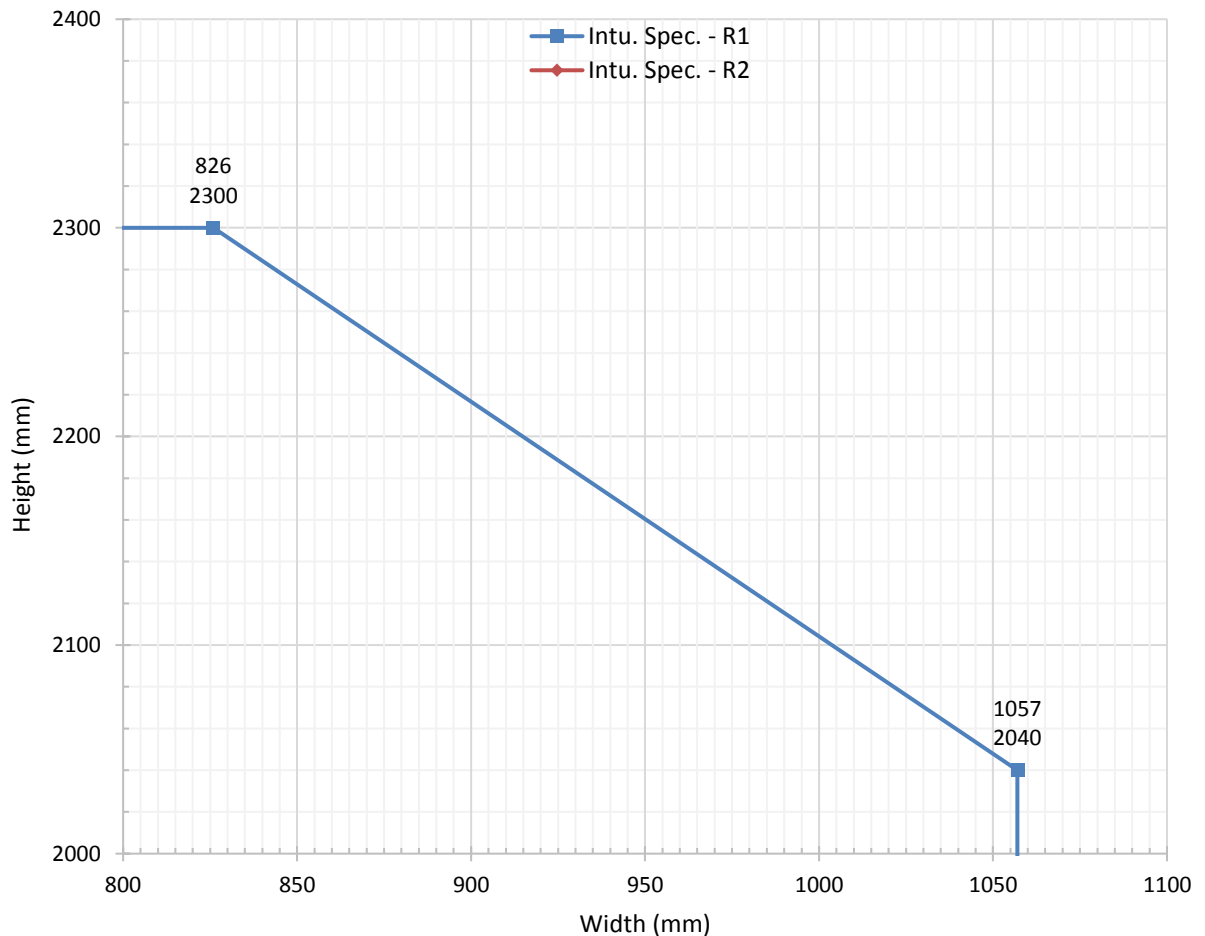

#### 4.5.5.18 6mm thick MDF (Leaf Type 5) Facings –ULSASD & DASD

Intumescent Specification for ULSASD & DASD Single Point Lock			
Intumescent Spec. Ref.	Type / Make	Manufacturer/ Supplier	Location, Size & Quantity
S1 (RF08116)	Rigid Box Seals	Pyroplex Ltd	Head & Jambs: 1No. 10 x 4mm exposed strip. Fitted centrally in the leaf edge or frame reveal to the head and jambs.
S2 (RF08116)	Rigid Box Seals	Pyroplex Ltd	Head & Jambs: Leaf Size in excess of 2300mm high. 1No. 15 x 4mm exposed strip. Fitted centrally in the leaf edge or frame reveal to the head and jambs.

ULSASD & DASD  
 (Single Point Lock)  
 Leaf Type 5  
 Intumescent specs S1 & S2 have the same leaf size envelope

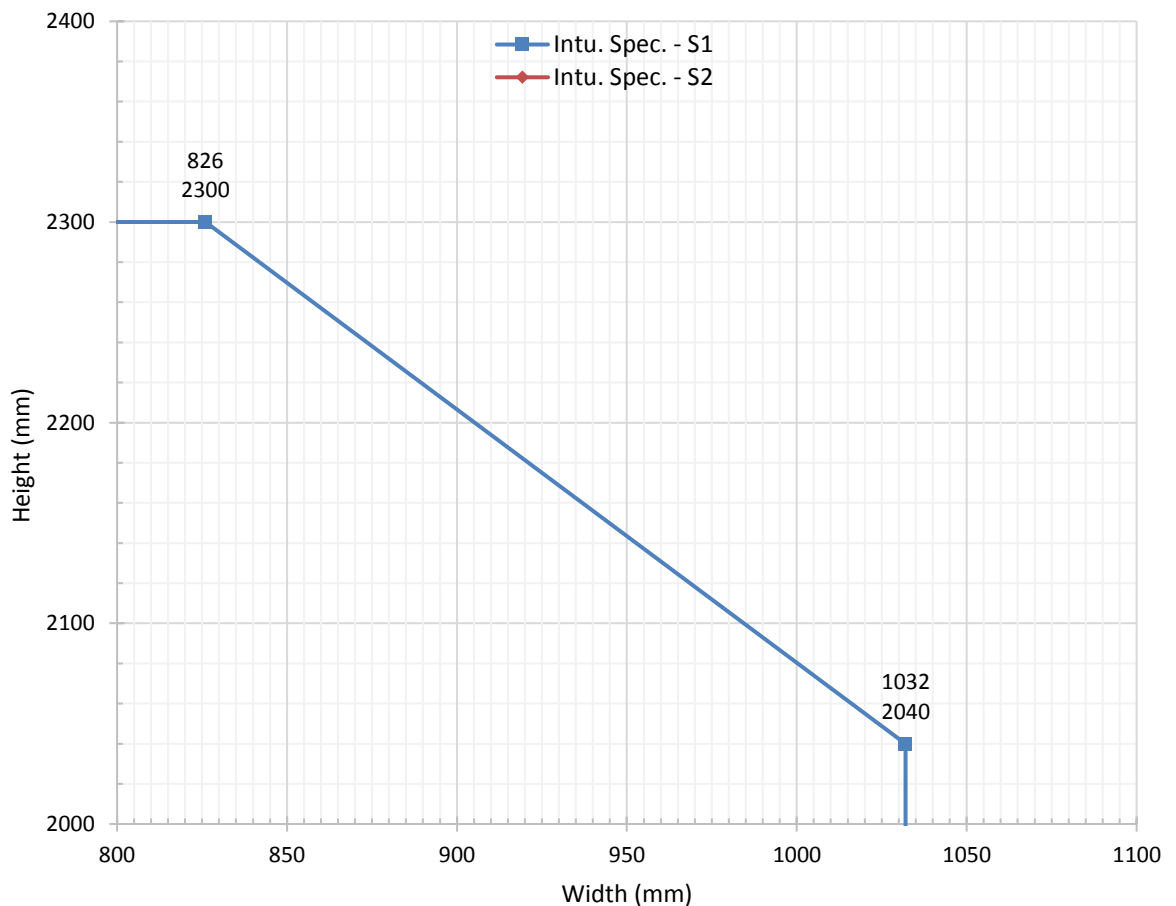

#### 4.5.5.19 9mm thick MDF (Leaf Type 6) Facings – LSASD

<b>Intumescent Specification For LSASD Single Point Lock</b>			
<b>Intumescent Spec. Ref.</b>	<b>Type / Make</b>	<b>Manufacturer/ Supplier</b>	<b>Location, Size &amp; Quantity</b>
T1 (RF08116)	Rigid Box Seals	Pyroplex Ltd	Head & Jambs: 1No. 20 x 4mm exposed strip. Fitted centrally in the leaf edge or frame reveal to the head and jambs.
T2 (RF00166)	Type 617 or Palusol 100	Lorient Polyproducts Ltd	Head & Jambs: 1No. 20 x 4mm exposed strip. Fitted centrally in the leaf edge or frame reveal to the head and jambs.
T3 (RF00166)	Type 617 or Palusol 100	Lorient Polyproducts Ltd	Head & Jambs: Leaf Size in excess of 2390mm high and/or 1100mm wide 1No. 25 x 4mm exposed strip. Fitted centrally in the leaf edge or frame reveal to the head and jambs.

### LSASD (Single Point Lock) Leaf Type 6

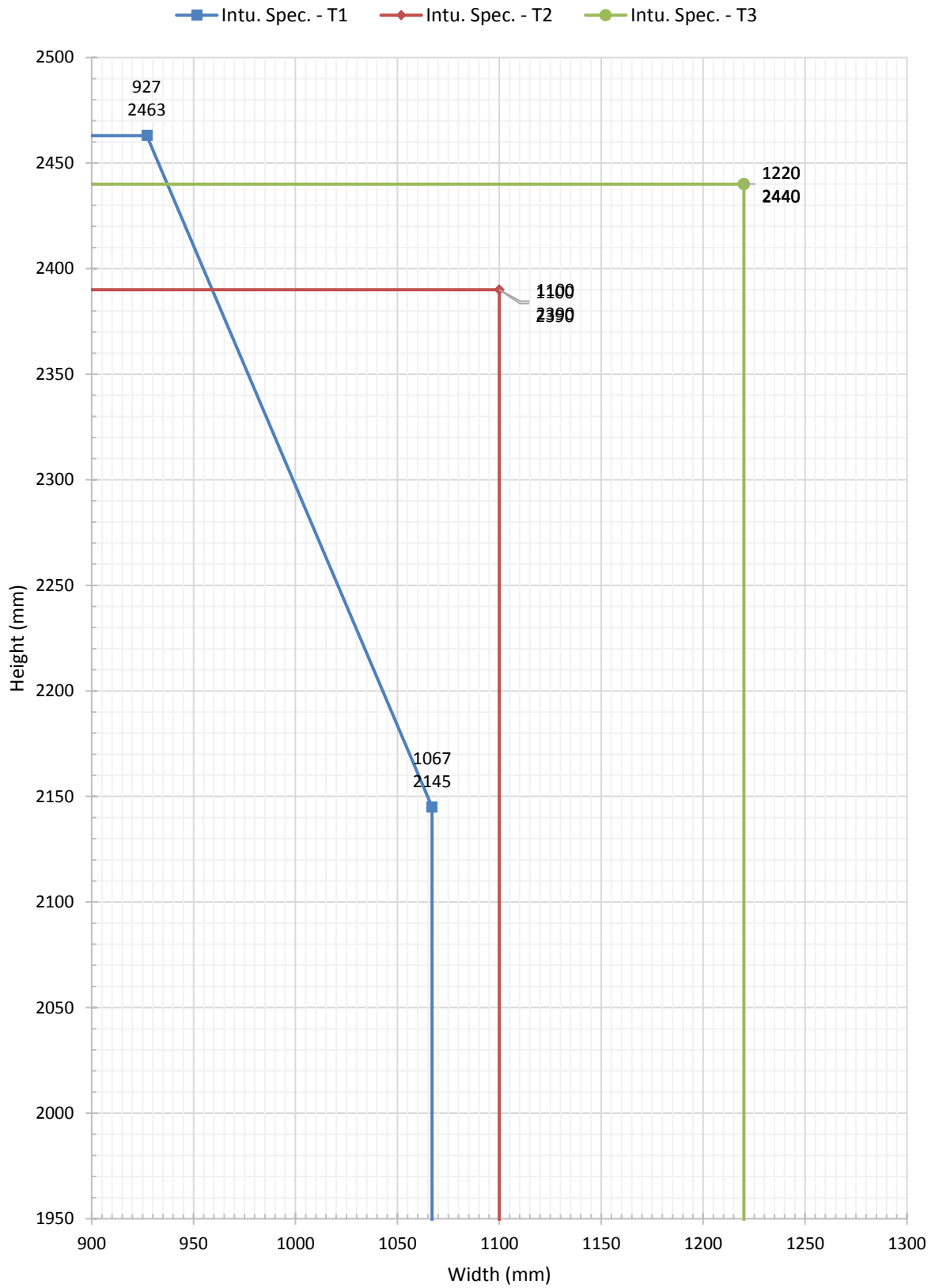

#### 4.5.5.20 9mm thick MDF (Leaf Type 6) Facings – ULSASD & DASD

<b>Intumescent Specification For: ULSASD &amp; DASD Single Point Lock</b>			
<b>Intumescent Spec. Ref.</b>	<b>Type / Make</b>	<b>Manufacturer/ Supplier</b>	<b>Location, Size &amp; Quantity</b>
V1 (RF08100 & RF08116)	Rigid Box Seals	Pyroplex Ltd	Head & Jambs: 1No. 20 x 4mm exposed strip. Fitted centrally in the leaf edge or frame reveal to the head and jambs.
V2 (RF00166)	Type 617 or Palusol 100	Lorient Polyproducts Ltd	Head & Jambs: 1No. 20 x 4mm exposed strip. Fitted centrally in the leaf edge or frame reveal to the head and jambs.
V3 (RF00166) Leaf Size in excess of 2390mm high and/or 1100mm wide	Type 617 or Palusol 100	Lorient Polyproducts Ltd	Head & Jambs: 1No. 25 x 4mm exposed strip. Fitted centrally in the leaf edge or frame reveal to the head and jambs.

ULSASD & DASD  
 (Single Point Lock)  
 Leaf Type 6

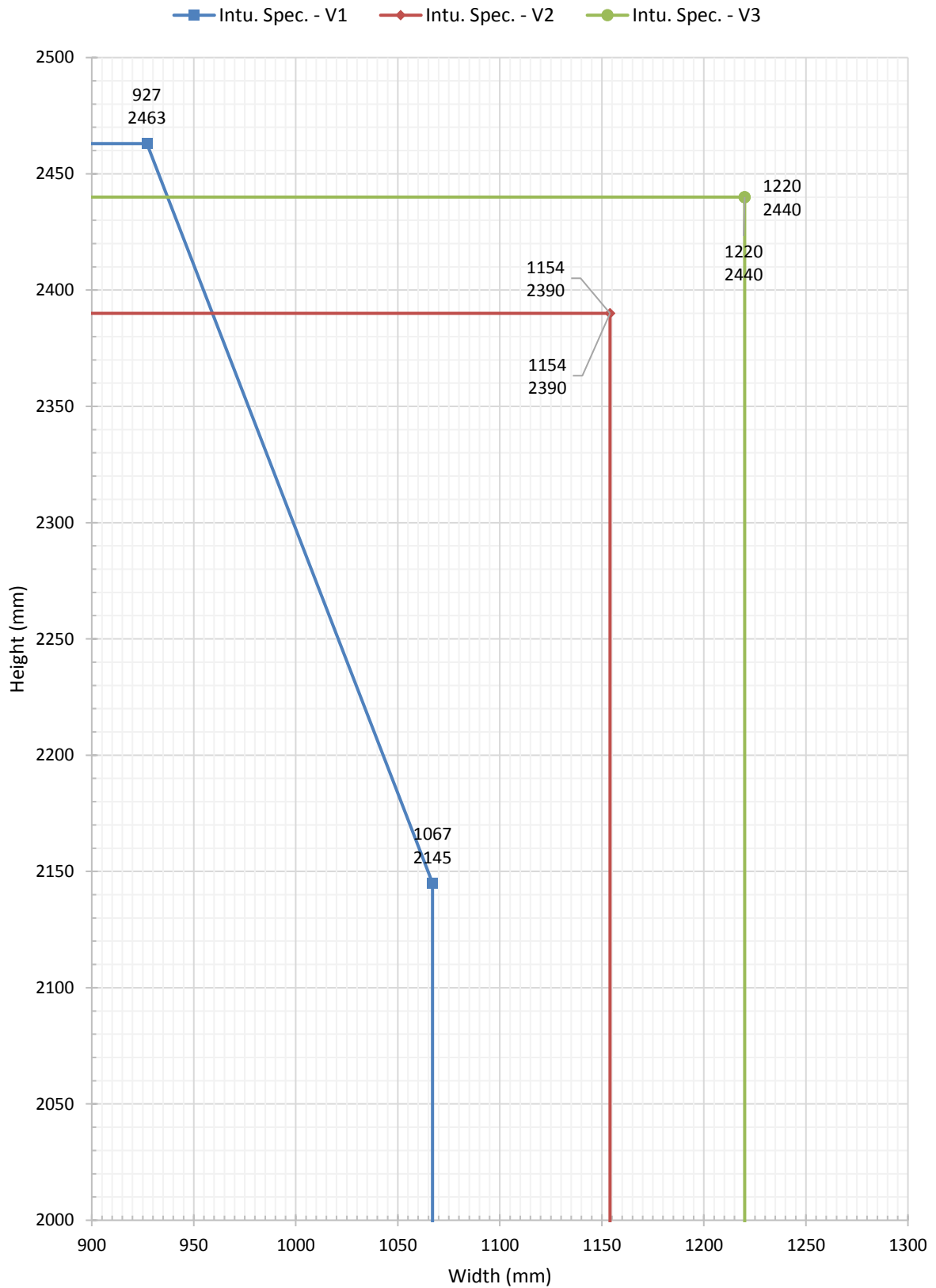

#### 4.5.5.21 4mm Thick Plywood (Leaf Type 1) Facings – LSASD & Multipoint Lock

Intumescent Specification For: LSASD Leaf Type 1 Multipoint Lock			
Intumescent Spec. Ref. (Test Ref)	Type / Make	Manufacturer/ Supplier	Location, Size & Quantity
X1 (18-003111-PR04)	ST154FO	Sealed Tight Solutions Ltd	<b>Head: &amp; Jambs:</b> 1No. 15 x 4mm PVC encapsulated seal fitted centrally in the frame reveals.
XA1 (WF535889)	Type 617	Lorient Polyproducts Ltd	<b>Head: &amp; Jambs:</b> 2No 10 x 4mm PVC encapsulated seals fitted centrally, 10mm apart, in the frame reveals.

LSASD - Leaf Type 1  
(Multi Point AV2)

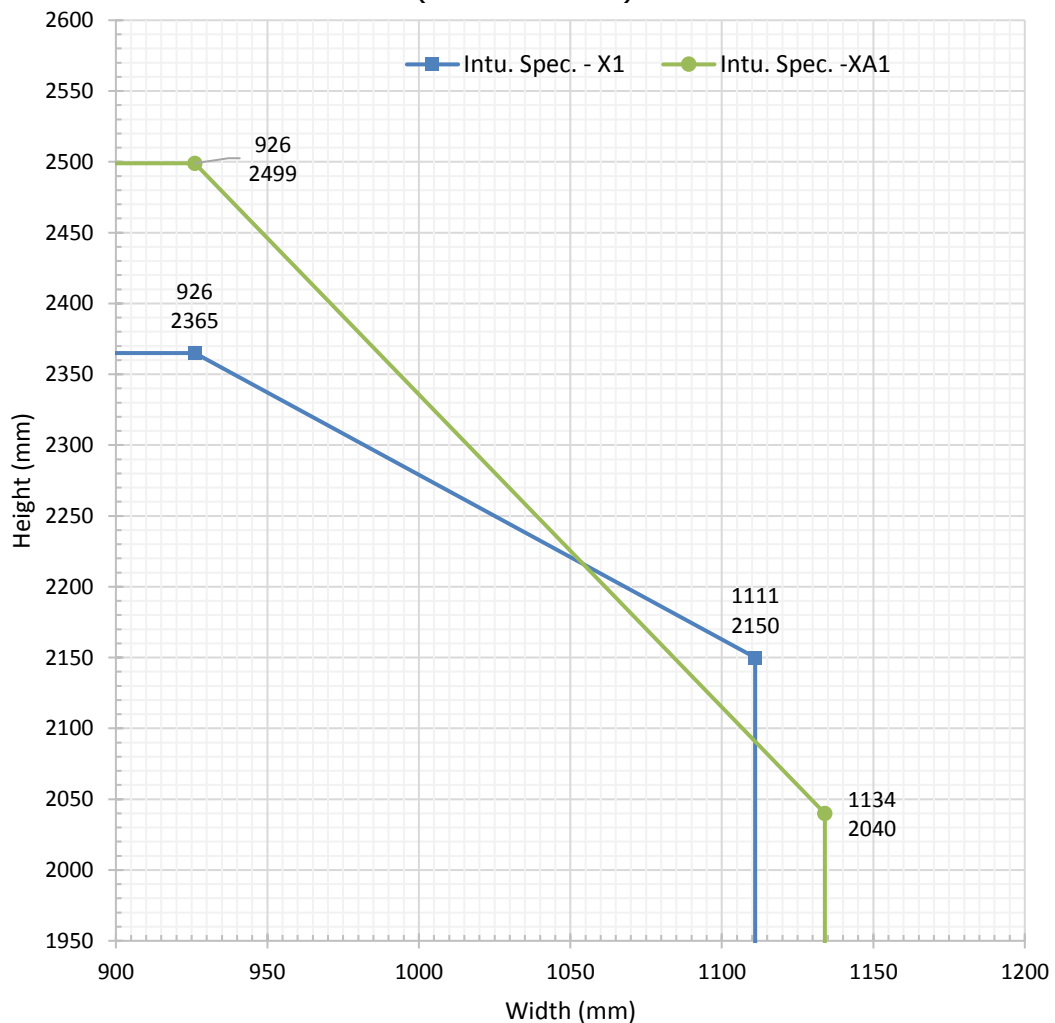

#### 4.5.5.22 All Leaf Facing Options (Leaf Types 1 – 6) – LSASD, ULSASD & DASD with Safehinge ALUmax

<b>Intumescent Specification</b>				
<b>For: LSASD, ULSASD &amp; DASD with Safehinge ALUmax</b>				
<b>Intumescent Spec. Ref. Y1 (Chilt/A12005 Revision G)</b>				
<b>Element</b>		<b>Make/type</b>	<b>Size (mm)</b>	<b>Location</b>
Leaf edges - hanging edge only		Lorient Polyproducts Ltd LP1504 Type 617	15 x 4	Fitted central to the leaf thickness on the external face of the Safehinge™ ALUmax ALU30 aluminium profile
		Lorient Polyproducts Ltd GPF1902 foamed graphite	19 x 2	Fitted central to the leaf thickness on the internal face of the Safehinge™ ALUmax ALU30 aluminium profile
Frame reveal	Head	Lorient Polyproducts Ltd LP1504DS Type 617	15 x 4	Fitted central in the frame reveal
	Jamb	Lorient Polyproducts Ltd LP1504DS Type 617	15 x 4	Fitted central in the frame reveal
Around top pivot		Fully interrupted	-	Top pivot fully interrupts seal in frame head
Under top pivot		Safehinge™ SHC35-035 graphite top centre wrap or Interdens wrap	1 thick 2 thick	Wrapped around the sides and base of the casing (frame)
		Safehinge™ SHC35-020 3No. intumescent pockets for strap	2 thick x 28 long x 14 wide	Fitted within the 'pockets' in the outer face of the top strap
Under upstand of bottom 'L' bracket pivot, when exposed		1. Interdens - Dufaylite Developments Ltd 2. Pyrostrip 300 Isa – Mann McGowan Ltd 3. MAP paper - Lorient Polyproducts Ltd 4. Therm-A-Strip - Intumescent Seals Ltd	1 thick	Fitted in the hanging jamb, under the upstand. See section 4.5.5.23.1 for installation diagrams



LSASD  
(Safehinge ALUmax)  
Leaf Types 1 - 6

—■ Intu. Spec. - Y1

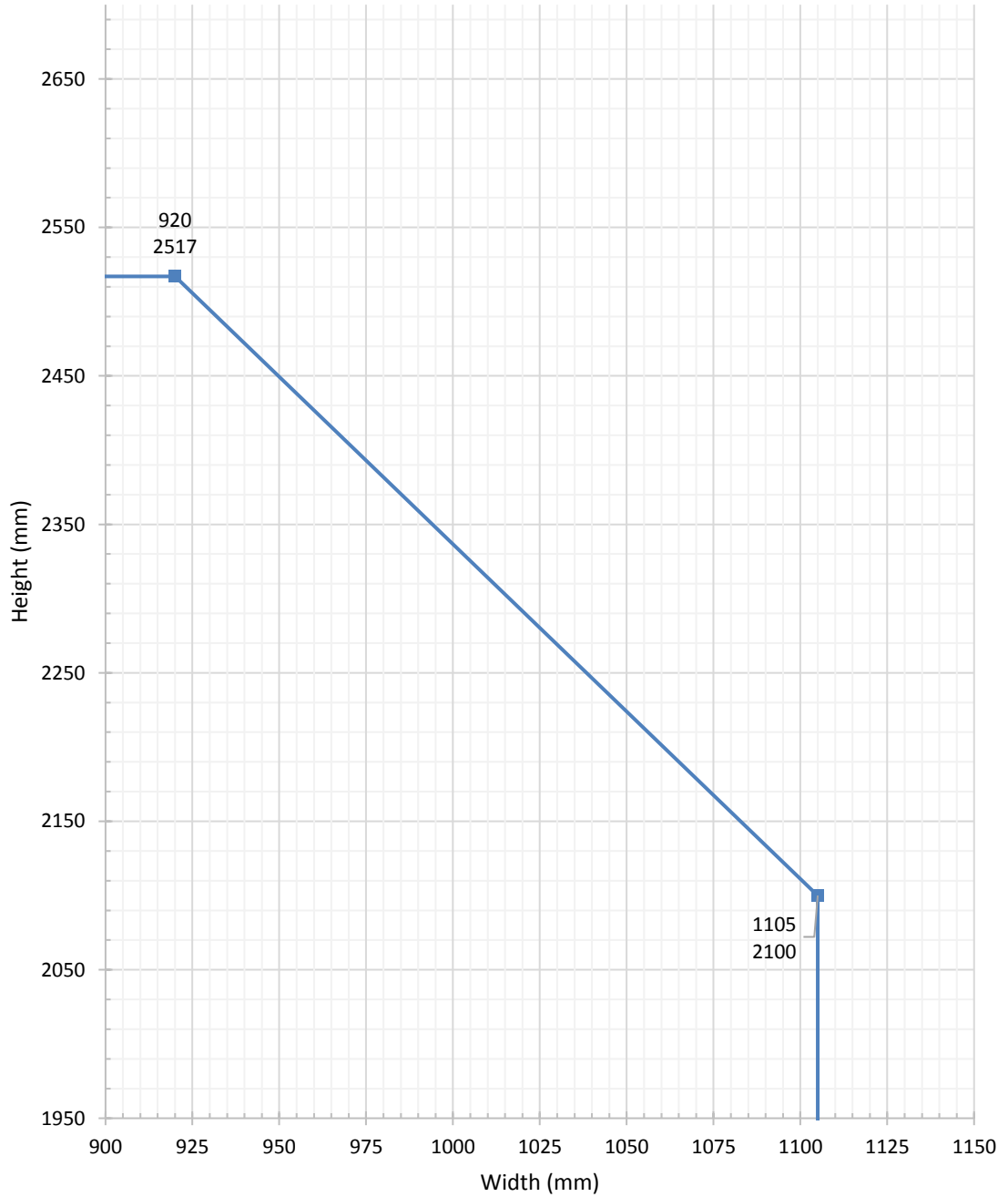

ULSASD & DASD  
(Safehinge ALUmax)  
Leaf Type 1 - 6

—■— Intum. Spec. -Y1

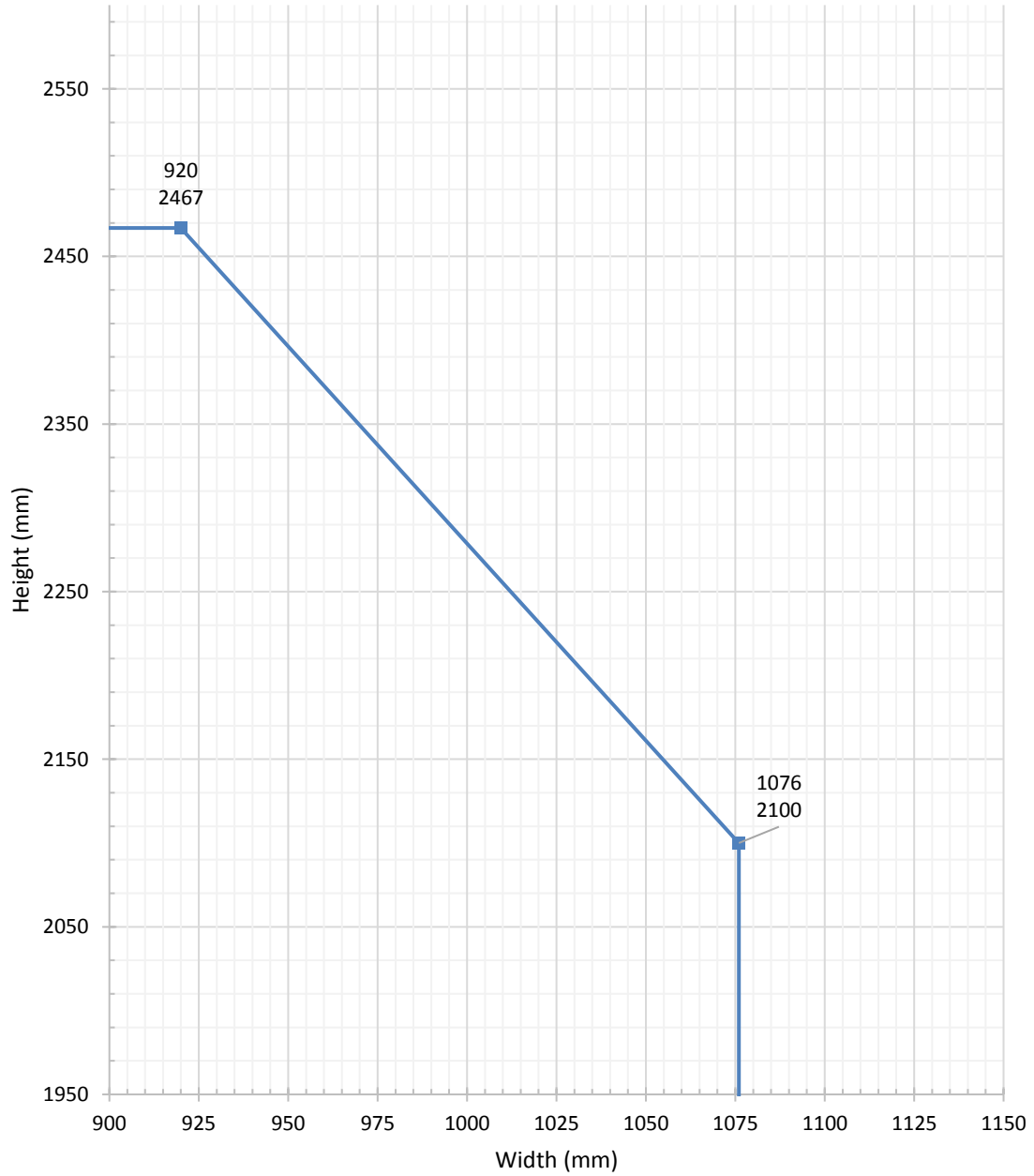

#### 4.5.5.23 All Leaf Facing Options (Leaf Types 1 – 6)– LSADD, ULSADD & DADD with Safehinge ALUmax

<b>Intumescent Specification</b>				
<b>For: LSADD, ULSADD &amp; DADD with Safehinge ALUmax</b>				
<b>Intumescent Spec. Ref. Z1 (Chilt/A12005 Revision G)</b>				
<b>Element</b>		<b>Make/type</b>	<b>Size (mm)</b>	<b>Location</b>
Leaf edges	Hanging edge only	Lorient Polyproducts Ltd LP1504 Type 617	15 x 4	Centrally fitted to leaf thickness on external face of Safehinge™ ALUmax ALU30 aluminium profile
		Lorient Polyproducts Ltd GPF1902 foamed graphite	19 x 2	Centrally fitted to leaf thickness on internal face of Safehinge™ ALUmax ALU30 aluminium profile
	Meeting edges	Lorient Polyproducts Ltd LP1004DS Type 617	10 x 4	2 No. seals spaced 10mm apart and centrally fitted in the meeting edge of one leaf only
Frame reveal	Head	Lorient Polyproducts Ltd LP2004DS Type 617	20 x 4	Fitted centrally in the frame reveal
	Jambs	Lorient Polyproducts Ltd LP1504DS Type 617	15 x 4	Fitted centrally in the frame reveal
Around top pivot		Fully interrupted	-	Top pivot fully interrupts seal in frame head
Under top pivot	Safehinge™ SHC35-035 graphite top centre wrap or Interdens wrap		1 thick 2 thick	Wrapped around the sides and base of the casing (frame)
	Safehinge™ SHC35-020 3No. intumescent pockets for strap		2 thick x 28 long x 14 wide	Fitted within the 'pockets' in the outer face of the top strap
Under upstand of bottom 'L' bracket pivot, when exposed		1. Interdens - Dufaylite Developments Ltd 2. Pyrostrip 300 Isa – Mann McGowan Ltd 3. MAP paper - Lorient Polyproducts Ltd 4. Therm-A-Strip - Intumescent Seals Ltd	1 thick	Fitted in the hanging jamb, under the upstand. See section 4.5.5.23.1 for installation diagrams

ULSADD & DADD  
(Safehinge ALUmax)  
Leaf Types 1 – 6

—■ Intum. Spec. - Z1

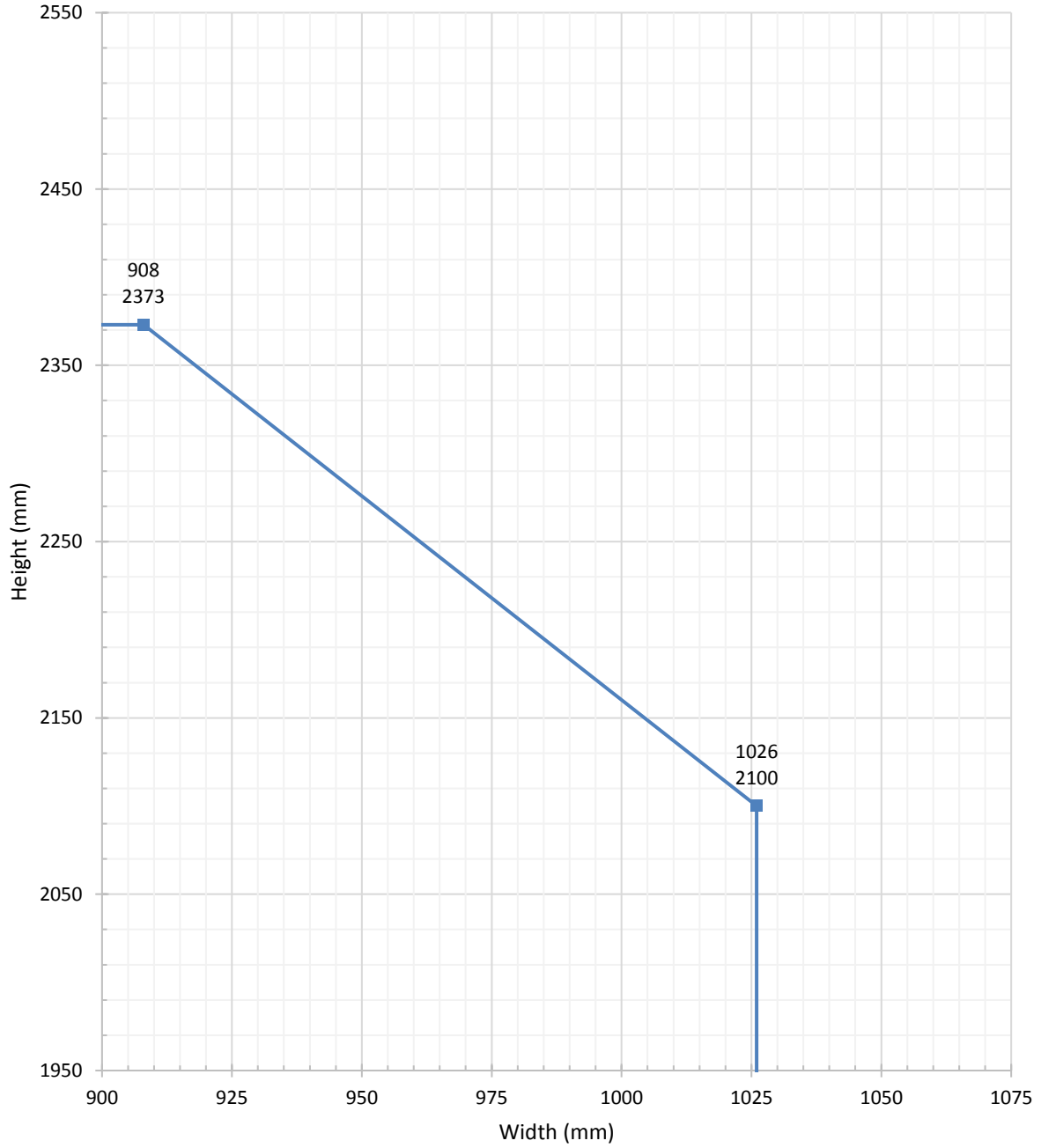

### LSADD (Safehinge ALUmax) Leaf Types 1 – 6

—■ Intum. Spec. - Z1

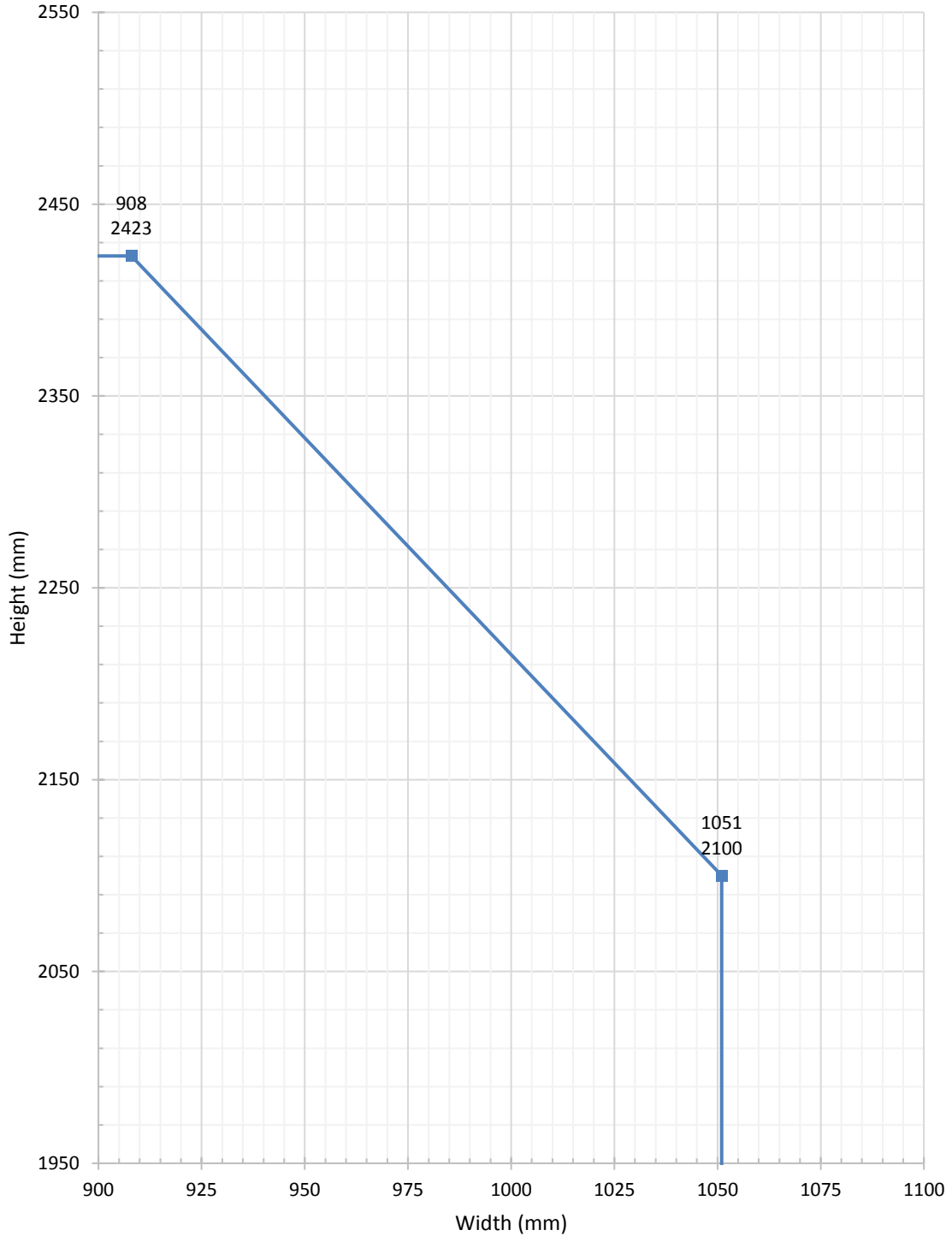

#### 4.5.5.23.1 Intumescent seal locations for 30 minute Safehinge™ ALUmax system

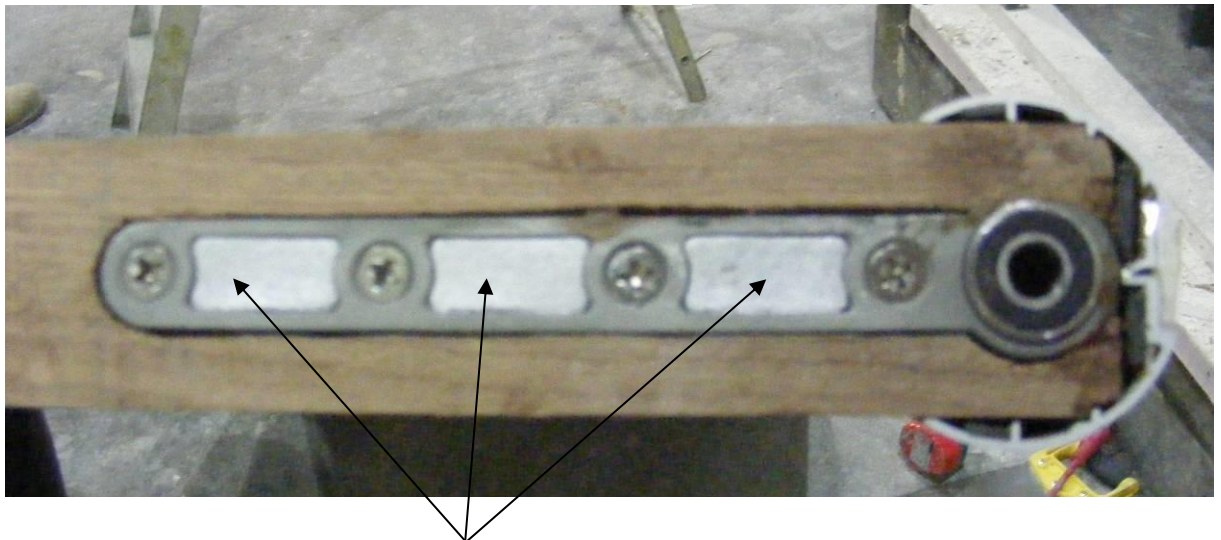
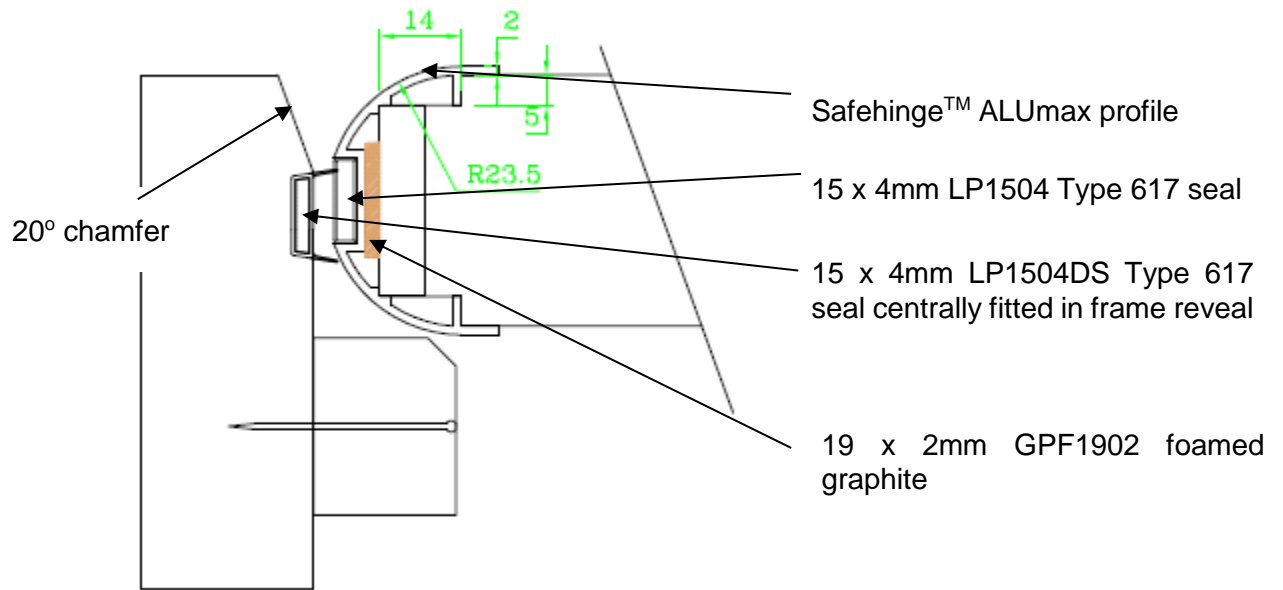

Approved intumescent pack in pockets of top pivot strap. The approved intumescent pack is also fitted around the sides and base of the casing.

#### 4.5.5.24 CS Group Edge Protectors/Acrovyn Wrap on 4mm Thick Plywood Facings (Leaf Type 1) – LSASD, ULSASD & DASD

Intumescent Specification For: LSASD, ULSASD & DASD with CS Group Edge Protectors/Acrovyn Wrap			
Intumescent Spec. Ref.	Type / Make	Manufacturer/ Supplier	Location, Size & Quantity
AA1 (Chilt/A11129 Revision E)	Type 617	Lorient Polyproducts Ltd	<b>Frame Head:</b> 1No. 15 x 4mm strip. Fitted centrally in the frame reveal. <b>Jamb:</b> 1No. 15 x 4mm strip fitted centrally in the leaf edges in addition to the intumescents integral to the edge protectors

LSASD, ULSASD & DASD  
 (CS Group)  
 Leaf Type 1

—■ Intu. Spec. - AA1

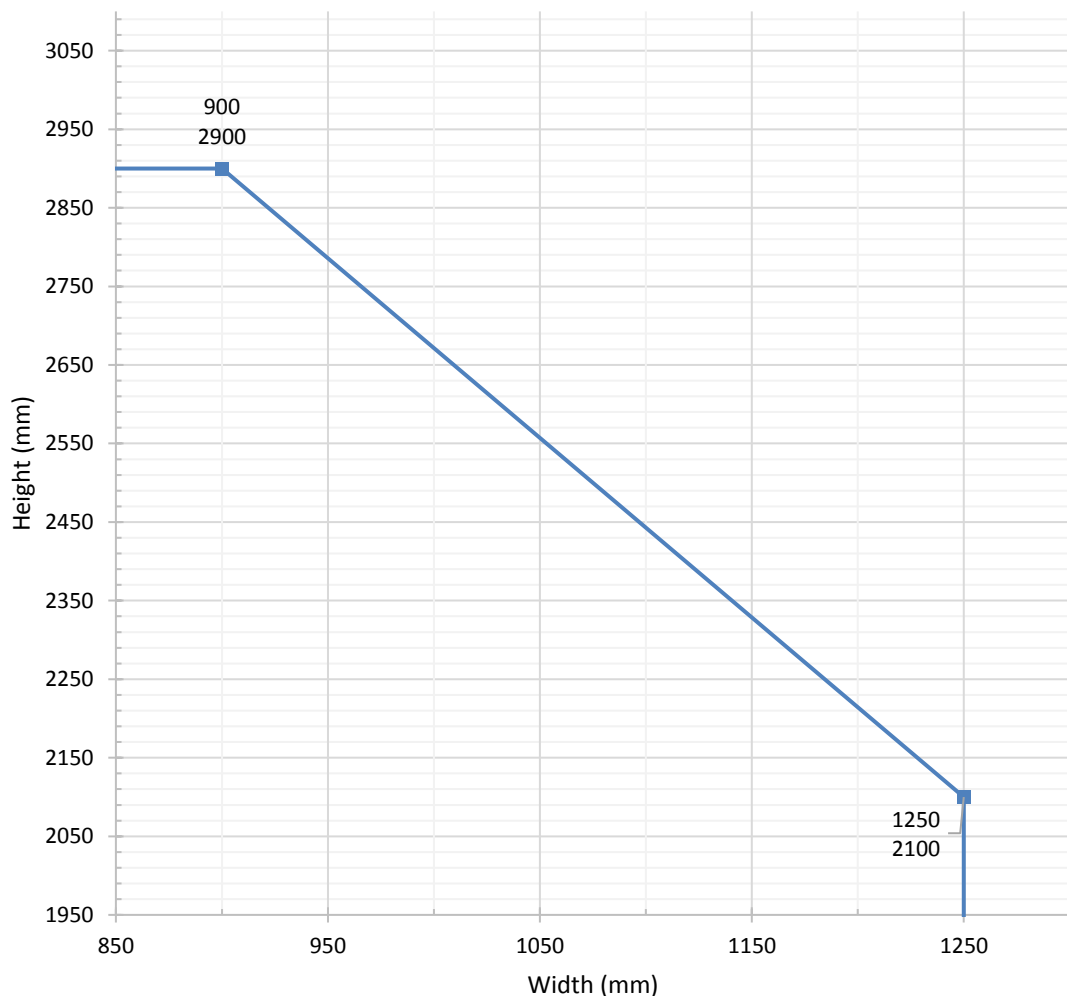

#### 4.5.5.25 CS Group Edge Protectors/Acrovyn Wrap on 4mm Thick Plywood Facings (Leaf Type 1) –LSADD, ULSADD& DADD

Intumescent Specification For: LSADD, ULSADD & DADD with CS Group Edge Protectors/Acrovyn Wrap			
Intumescent Spec. Ref.	Type / Make	Manufacturer/ Supplier	Location, Size & Quantity
BD1 (Chilt/A11129 Revision E)	Type 617	Lorient Polyproducts Ltd	<b>Frame Head:</b> 1No. 15 x 4mm strip. Fitted centrally in the frame reveal. <b>Jamb:</b> 1No. 15 x 4mm strip fitted centrally in the leaf edges in addition to the intumescents integral to the edge protectors <b>Meeting Edges:</b> 1No. 15 x 4mm seal fitted centrally in the CS edge protectors which must be fitted to the meeting edges of both leaves

LSADD, ULSADD & DADD  
 (CS Group)  
 Leaf Type 1

—■ Intu. Spec. - BD1

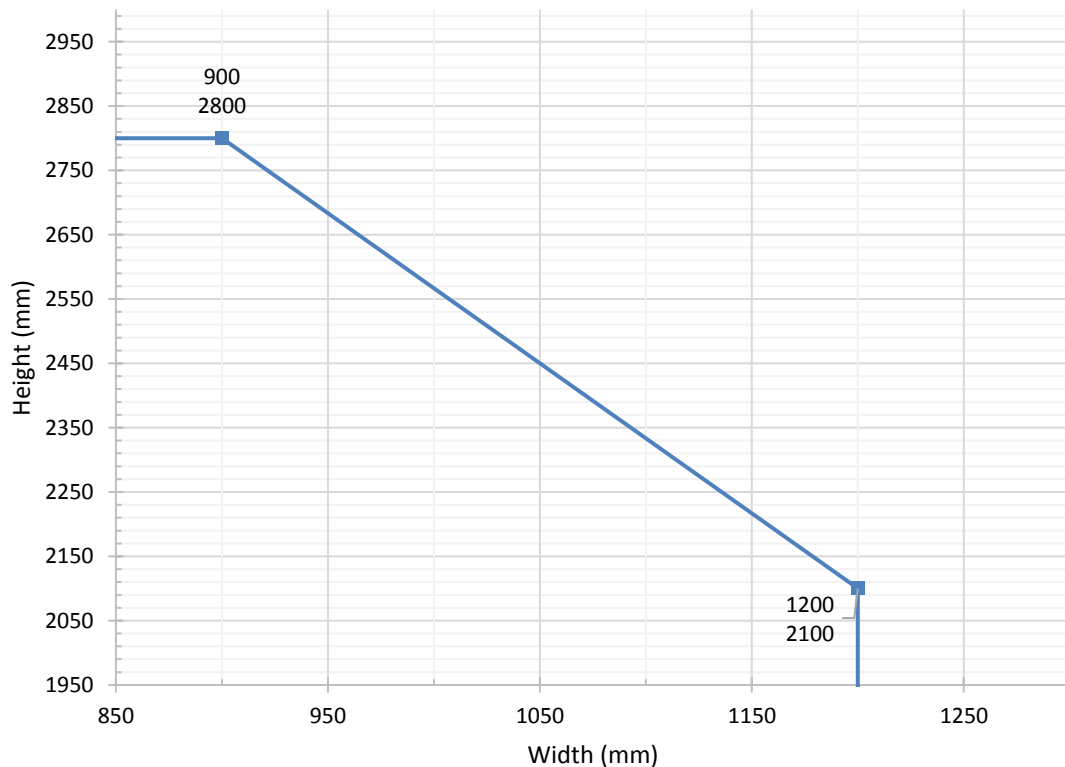



#### 4.5.5.26 Yeoman Shield/Lorient Edge Protectors on 4mm Thick Plywood Facings (Leaf Type 1) LSASD, ULSASD & DASD

Latched & Unlatched, Single & Double Acting, Single Doorsets Using Yeoman Shield/Lorient Edge Protectors - Single Point Lock			
Intumescent Spec. Ref.	Type / Make	Manufacturer/ Supplier	Location, Size & Quantity
AB1 (Chilt/A08001 Revision D)	Type 617 –	Lorient Polyproducts Ltd.	Head: 1No. 1No. 20 x 4mm seal fitted centrally in the frame head. Jamb: 1No. 15 x 4mm fitted centrally in Yeoman Shield/Lorient PVCu edge protectors.

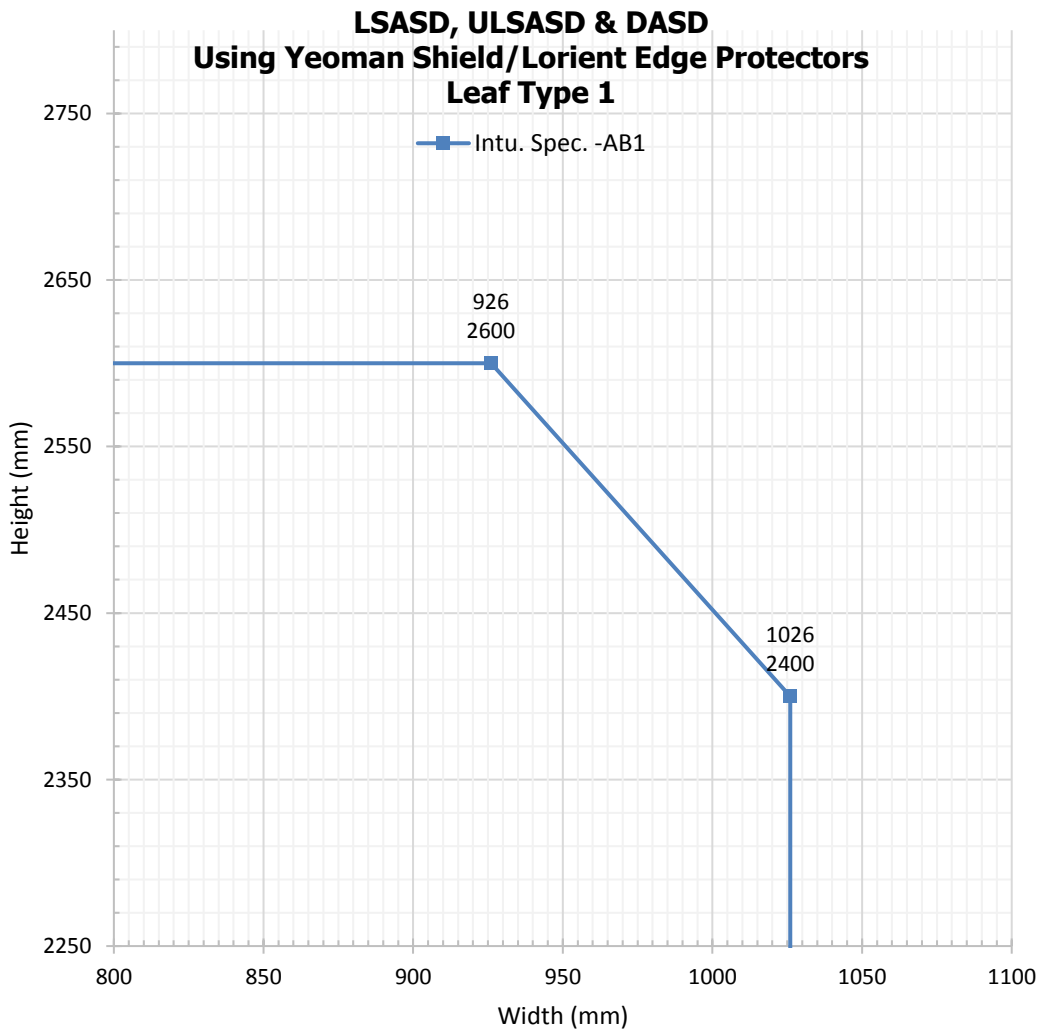

#### 4.5.5.27 Yeoman Shield/Lorient Edge Protectors on 4mm Thick Plywood Facings (Leaf Type 1) LSADD, ULSADD & DADD

Latched & Unlatched, Single & Double Acting, Double Doorsets Using Yeoman Shield/Lorient Edge Protectors - Single Point Lock			
Intumescent Spec. Ref.	Type / Make	Manufacturer/ Supplier	Location, Size & Quantity
BD2 (Chilt/A08001 Revision D)	Type 617	Lorient Polyproducts Ltd.	<p><b>Head:</b> 1No. 20 x 4mm seal fitted centrally in the frame head.</p> <p><b>Jambs:</b> 1No. 15 x 4mm fitted centrally in Yeoman Shield/Lorient PVCu edge protectors.</p> <p><b>Meeting Edges:</b> 1No. 15 x 4mm fitted centrally in the Yeoman Shield/Lorient PVCu edge protectors of both leaves.</p>

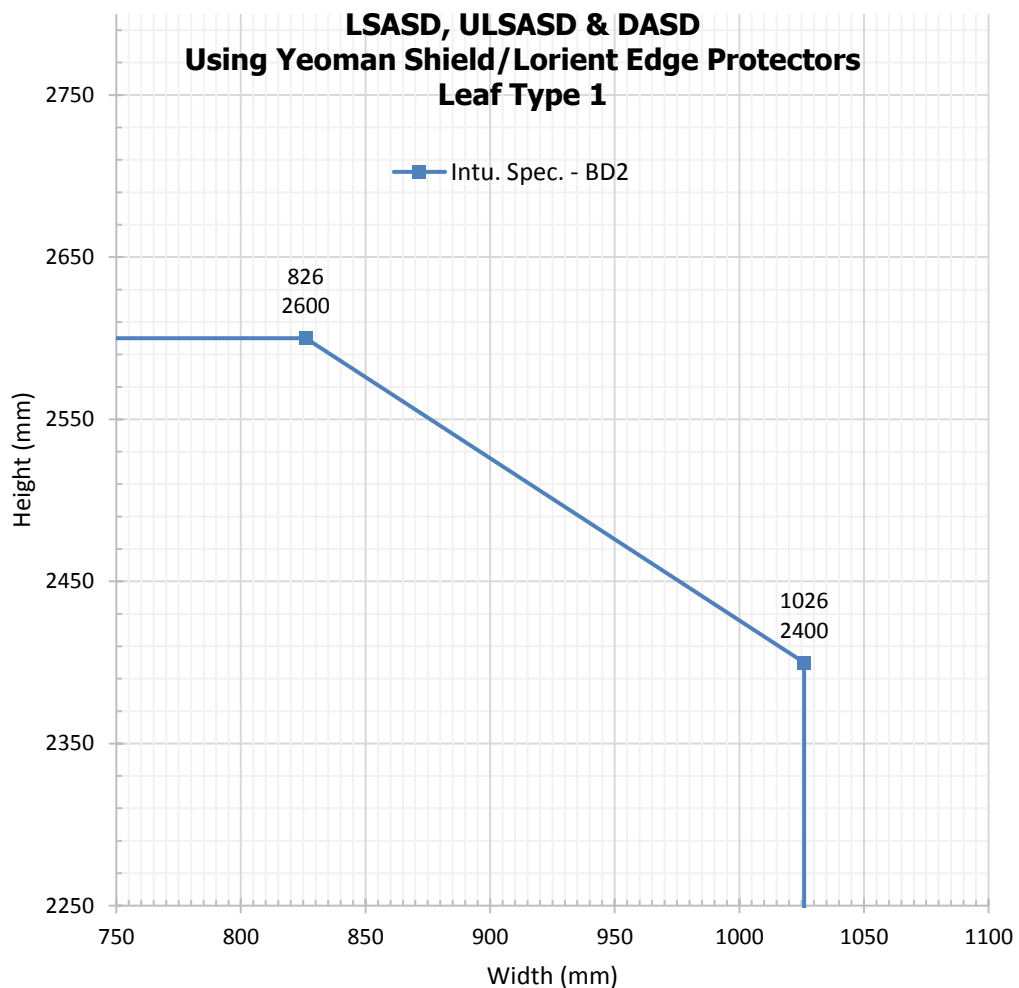

## 5 General Description of Construction

### 5.1 Leaf Core Construction

The door leaf options detailed below are approved by this FoA.

#### 5.1.1 All Leaf Types – 44mm thick

The essential construction of the Flamebreak 30 minute door leaf includes the following basic components in the design.

Element	Materials	Dimensions (mm)	Minimum Density (kg/m <sup>3</sup> )
Core	Parasoriantes falacateria or Albisia falcatta or Ochroma pyramidale	3 layers of lamels laid in alternate directions – grooved to accept the stiles and rails	140-360 (average 210)
Stiles: Mixed tropical hardwood	Leaf size greater than 2135 (h) x 915 (w)	1No. 26 - 36 thick (depending on facing thickness) x 35 deep, incorporating a 9 x 9 tongue to locate into the core material	480
	Leaf size ≤ 2135 (h) x 915 (w)	1No. 26 – 36 thick (depending on facing thickness) x 35 deep	480
Top & bottom rails	'Mixed tropical hardwood'	1No. 26 - 36 thick (depending on facing thickness) x 35 deep, incorporating a 9 x 9 tongue to locate into the core material	480
Facings	Various timber-based products – see section 5.3 for details	Between 4 – 9mm thick – see section 5.1.2	Various
Lippings	Hardwood	See section 5.2.	

The permitted dimensions, configurations and required intumescent materials for the Flamebreak cores used for 30 minute fire resisting applications may vary according to the material and thickness of the facing material. These restrictions are defined by reference to the data sheets in section 4.5.5.

Flamebreak 30 core constructions that include perimeter framing (stiles and rails) may be used for 30 minute applications without the addition of lippings, subject to the requirements within section 5.2.

Flamebreak 30 minute door leaves may be supplied without stiles and/or bottom rails by Pacific Rim Wood Ltd. for subsequent conversion within door assemblies. Lippings must always subsequently be applied meeting the specification in section 5.2.

### 5.2 Leaf Edging Materials

Flamebreak 30 door cores are supplied with structural perimeter framing around the tri-laminated core. The design has been tested without additional lippings and this variation to design is to be referenced as 'edge banded', see section 5.2.2 for details.

When, during manufacture, the structural framing is removed, the resulting door leaf must be lipped, in line with the requirements of section 5.2.1.

Door leaves must always be either lipped or retain an element of internal framing, the requirements for each approach are given below.

### 5.2.1 Where Timber Lippings Required

When door blanks to the Flamebreak 30 design have been cut on the vertical (long) leaf edges removing the leaf framing or have been supplied without leaf framing, they must be lipped meeting the specification in section 5.2.3. Where lippings are to be utilised:

- The vertical perimeter framing to the core can be removed completely to one or both sides of the core.
- The structural head rail can be reduced by the thickness of the lipping material to be added plus a maximum of 3mm.
- There are no restrictions regarding reduction to the bottom rail.

### 5.2.2 Blanks without Lippings (Edge Banded)

Flamebreak 30 core constructions that include perimeter framing (stiles and rails) may be used for 30 minute applications without the addition of lippings subject to the following limitations:

- The vertical perimeter stiles may be reduced by up to 50% of the original dimension provided that the reduction is applied equally to both stiles.
- The head rail must not be reduced by more than 3mm.
- There are no restrictions regarding reduction or removal of the bottom rail.

### 5.2.3 Lipping Material Specification

Flamebreak blanks supplied by Pacific Rim Wood may be pre-lipped during factory production. These lippings comprise a 'T-shape' with a 25mm wide by 8mm deep tongue to locate within the core or leaf framing, this detail was sampled by BM TRADA within the tested specimens in test WF522957 detailed in appendix A. The lipping dimensions below refer to the full leaf thickness element of lippings.

Material	Size (mm)	Min. Density (kg/m <sup>3</sup> )
Hardwood -must be straight grained, joinery quality, free from knots, splits, and checks.	1. Flat = 6 – 18 thick with a maximum of 2 profiling permitted at corners of lipping (see section 7.1)	640
	2. Rounded = 8 – 20 thick with a radius matching the distance between leaf edge and floor pivot (see section 7.1)	
	3. Rebated = 20 – 30 thick with a 12 deep equal rebate (meeting edges of double doors & flush overpanel junction only – see notes below)	

#### Notes:

The following notes apply irrespective of whether the leaf framing is intact or not.

- Doorsets with flush overpanels must be lipped on the vertical edges and additionally at the bottom edge of the overpanel and top edge of the doors.
- Where applied, lippings along the vertical edges must over-run the lippings along the horizontal edges.

- Lippings can be bonded with Urea formaldehyde, resorcinol formaldehyde or PU. These may be hand applied or may be applied using an edgebander. With either method it must be ensured that sufficient glue is applied to across the entire surface area between the 2No substrates being adhered to guarantee a robust bond. Other manufacturers guidance should be followed, for either installation application.
- For flat lippings it is permitted to apply maximum 8mm radius to the corners of the lipping at vertical edges to create a maximum 2mm edge profiling
- For rounded lippings a minimum of 6 to 8mm thickness of lipping shall be measured at the face of the door leaf where the lipping is its minimum thickness
- Double doorsets without flush overpanels are permitted with square or rebated meeting edges.
- Single leaf doorsets with flush overpanels may use a rebated overpanel junction.
- Double doorsets with flush overpanels may use a rebated overpanel junction or rebated meeting edges but must not use both concurrently.

#### 5.2.4 Meeting Stile Astragals

Generally, fire doors should be able to open simultaneously. However, where additional performances are required (e.g. acoustic performances) it may be necessary to provide for sequential opening. See section 10.9.4 for details of door selectors, one of which must also be installed.

An astragal detail may be used where these conditions apply, without adverse influence on existing fire test/assessment data.

Astragals can be applied to both door leaves and may be profiled for aesthetic effect providing they meet the minimum specification given below.

The hardwood for the astragal must be hardwood of the same minimum density being used for the lipping material. See following diagram.

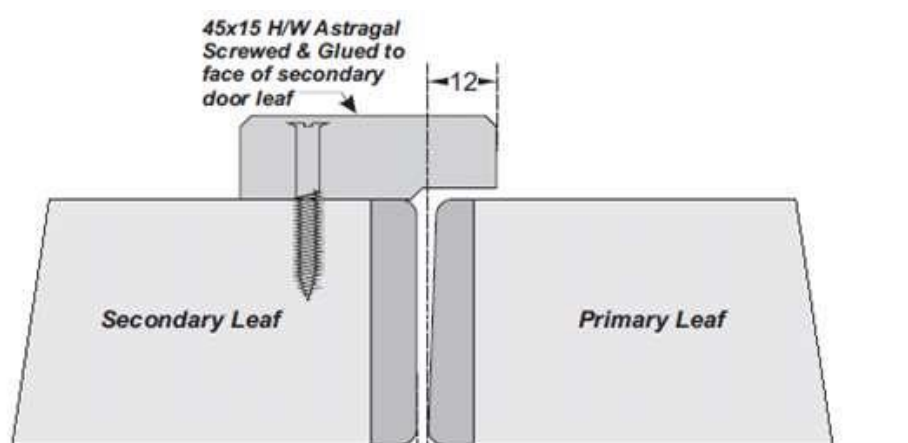

## 5.2.5 Planted Stop for Flush Overpanels

For single acting doorsets with flush overpanels it may be necessary to provide for a planted stop detail at the junction between the overpanel and the leaf heads. The planted stop is to have the same specification as that given for the meeting edge astragal in section 5.2.4. See following diagram for recommended installation detail.

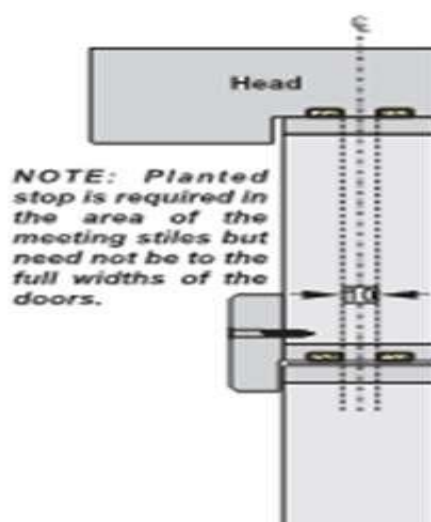

## 5.3 Leaf Facings Materials

As shown in section 4.3, a number of facing types and thicknesses are permitted herein. Limitations resulting from the specified facing type are detailed throughout this FoA including leaf size envelopes in section 4.5.5.

### 5.3.1.1 Decorative & Protective Facings – all Leaf Type Options

Relatively thin leaf facing materials are deemed to be decorative and their application is not considered to be of detriment to the overall stability or performance of the doorset design. In fact, when applied as an additional component on top of the minimum facing material required by the door blank, they are likely to provide a small enhancement in performance as an additional barrier to fire spread, although, this is likely to be negligible.

The following additional facing materials are therefore permitted to the leaf for this door design since they would have limited influence under fire resistance test conditions.

Facing Material	Maximum Permitted Thickness (mm)
Paint <sup>5</sup>	0.2
Timber veneers <sup>3</sup>	2
Plastic laminates <sup>3</sup>	2
PVC <sup>3</sup>	2
Cellulosic and non-metallic foils <sup>3</sup>	0.4

#### Notes:

1. Metallic facings are not permitted except for push plates and kick plates.
2. The door leaf thickness may be reduced on both sides by a maximum of 0.5mm for calibration purposes in order to accommodate the chosen finish. The minimum overall leaf thickness must remain at 44mm after finishing has been applied.
3. Materials may over sail lippings but must not return around leaf edges.
4. For all options, materials must not conceal intumescent strips.
5. Intumescent paints are not permitted.

Decorative finishes listed above may be painted within the limits for paint finish in note 1 above.

## 5.4 Decorative Planted on Timber Mouldings – all Leaf Types

Decorative mouldings can be applied to all Flamebreak leaf types 1 - 6, providing the following criteria is adhered to:

The mouldings:

1. Are surface applied to the door.
2. Are no higher than 30mm i.e. proud of the door.
3. Are no wider than 50mm.
4. Cover no more than 20% of the door leaf area.
5. Are no closer than 80mm to the door leaf edge.
6. The mouldings must be bonded in place using UF, PF, PVA, PVAC or PU glue.
7. Mechanical fixings may be used, the tested 23 gauge headless nails are acceptable, at a minimum of 50mm from the ends of mouldings and at no less than 200mm centres.

## 5.5 Feature Grooves

Based on the results of WF381914, with no burn through of the leaf prior to 44 minutes, Flamebreak 30 doorsets may be grooved meeting the following specification.

Maximum permitted groove dimensions:

- 2mm deep x 10mm wide
- 3mm deep x 3mm wide 'V' shaped.

Grooves with smaller dimensions may be machined in the leaf faces, the limitations below will still apply.

Permitted Facing types	Density (kg/m <sup>3</sup> )	Thickness (mm)
Plywood	520	4, 6 or 9mm
Chipboard	500	6 or 9mm
MDF	710	

### Notes:

1. Grooves may run to the leaf edges.
2. Horizontal grooves must be no closer than 100mm to the top and bottom of the door leaf.
3. Vertical grooves must be no closer than 100mm to the sides of the door leaf.
4. Grooves should be no closer than 100mm to each other vertically or horizontally grooves are permitted perpendicular to one another (permitted to intersect) providing all other details meet the specification given above.
5. Grooves must not run under glazing beads, where these are also installed.
6. Provided the restrictions above are complied with, there is no restriction on the number of grooves permitted.
7. Feature grooves are not permitted with flush overpanel configurations.

## 5.6 PVC Edge Protectors & Post-Formed CS Group Acrovyn

### 5.6.1 CS Group Edge Protectors

The Pacific Rim Wood Ltd. Flamebreak 30 design has been assessed for use with CS Group edge protectors based on the supporting test evidence contained within Chilt/A11129 Revision E (RF11059, IF11010A and IF13094). CS Group edge protectors are supplied pre-formed with the approved intumescent material. The CS Group edge protectors must be used as part of a complete intumescent system and the required intumescent specification and leaf sizes are given in the relevant data sheets in section 4.5.5. CS Group edge protectors must only be fitted to new doorsets, i.e. they must not be retrofitted to existing doorsets. CS Group must be contacted for precise installation and fixing details ([www.c-sgroup.co.uk](http://www.c-sgroup.co.uk)).

The Flamebreak leaf type 1 with 4mm plywood facings can be fitted with the proprietary edge protectors detailed in this section, up to the maximum dimensions stated in the CS Group headed data sheets in section 4.5.5.24 & 4.5.5.25.

All other alternatively faced Flamebreak designs (see section 4.3) can be fitted with the proprietary edge protectors within the dimensions stated in the relevant data sheets in sections 4.5.5.24 & 4.5.5.25 but cannot exceed the maximum leaf dimensions given in the data sheet in the relevant section within section 4.5.5 for the particular Flamebreak leaf type (2 – 6) intended for use.

Based on the testing cited in section 3, the following limitations apply to locks/latches when using the CS Group Edge Protectors and takes precedence over the specification in section 10.4. The use of multipoint locks is not permitted.

**Lock/Latch Type:** – where fitted - single point engagement only

**Configurations:** LSASD ULSASD, DASD, LSADD, ULSADD & DADD.

Lock/latches with the following specification are deemed acceptable.

#### **Single and Double leaf doorsets**

Element	Specification
Maximum forend and strike plate dimensions	155mm high x 25mm wide x 4mm thick
Maximum body dimensions	150mm high x 100mm wide x 18mm thick
Intumescent protection	see section 10.2
Materials	All parts essential to the locking/latching action (including the latch bolt, forend and strike) to be steel, stainless steel or brass with a melting point $\geq 800^{\circ}$ C

#### Notes:

1. In all instances the location of the handle must be between 800 – 1100mm from the threshold.



### 5.6.2 Yeoman Shield/Lorient PVCu Edge Protectors

The Pacific Rim Wood Ltd. Flamebreak 30 design has been assessed for use with the Yeoman Shield/Lorient PVCu edge protectors based on the supporting data contained within Chilt/A08001 Revision D and the following specification.

1. The Yeoman Shield/Lorient edge protectors must be used as part of a complete intumescent system and the required intumescent specification and leaf sizes are given in the relevant data sheet in sections 4.5.5.26 & 4.5.5.27.
2. The Yeoman Shield/Lorient edge protectors must be fitted to vertical leaf edges only.
3. It is permitted to fit the edge protectors to one or both vertical leaf edges of a door leaf.
4. If Yeoman Shield/Lorient edge protectors are required at the meeting edges of double doorsets, they must be fitted to both meeting edges.
5. Timber lippings must be fitted, as per the specification given in section 5.2 above.
6. Timber lippings must be square, with no profiling permitted and containing no intumescent material.
7. The Yeoman Shield/Lorient edge protectors must be fixed with 50mm long No. 6- 8 steel wood screws, with a fixing no more than 150mm from the top and bottom of the edge protector and at maximum 200mm centres in between.
8. The PVC elements must be adhered to the door leaf using PVA adhesive, as detailed in section 9.

The Flamebreak leaf type 1 with 4mm plywood facings may be fitted with the Yeoman Shield/Lorient edge protectors up to the maximum dimensions stated in the Yeoman Shield/Lorient headed data sheets in sections 4.5.5.26 & 4.5.5.27.

All other alternatively faced Flamebreak designs (see section 4.3) can be fitted with the proprietary edge protectors within the dimensions stated in the relevant data sheets in sections 4.5.5.26 & 4.5.5.27 but cannot exceed the maximum leaf dimensions given in the data sheet in the relevant section within section 4.5.5 for the particular Flamebreak leaf type (2 – 6) intended for use.

### 5.6.3 Post-Formed CS Group Acrovyn

It is permitted to encapsulate the Flamebreak 30 doorset design by post-forming the leaf in CS Group Acrovyn, based on test Chilt/RF11059 and the following specification.

1. CS Group Acrovyn must be wrapped around the vertical edges of the leaf only, i.e. the top and bottom of the leaf must remain exposed.
2. The vertical edge detail prior to post-forming must either be lipped with 8mm thick PVC, or hardwood as detailed in this assessment (see section 5.2.3)
3. The maximum radius of the lipping at the corners of the vertical edges before post-forming must be 9mm, which provides for 11mm external radius after the CS Group Acrovyn has been applied.
4. The intumescent detail as specified in the relevant (CS Group headed) data sheets contained in sections 4.5.5.24 & 4.5.5.25 of this FoA must be replicated.
5. CS Group Acrovyn must be bonded to the leaf using 3M Scotch-Grip cement 10 contact adhesive, or equivalent.
6. See relevant (CS Group headed) data sheets in section 4.5.5.24 & 4.5.5.25 of this assessment for maximum permitted leaf sizes.
7. The maximum thickness of CS Group Acrovyn used must be 2mm, as tested.
8. The CS Group Acrovyn can be provided as pre-formed trays with dimensions to suit the proposed leaf sizes, as well as sheets for post-forming by the door manufacturer.

## 6 Glazing within the Leaf

### 6.1 General

The testing conducted on Pacific Rim Wood Ltd. Flamebreak 30 designs has demonstrated that they are capable of tolerating glazed apertures, whilst providing a margin of over performance, this is supported by the summarised test evidence within section 3. For example, test reference RF08100 included a glazed aperture 1040mm high x 700mm wide fitted with 7mm thick Pilkington UK Ltd Pyroshield glass which achieved 51 minutes integrity performance. Test WF522957 incorporated 2No glazed apertures and achieved 36 minutes integrity performance.

Glazing is therefore acceptable within the following parameters.

Apertures must not be less than 100mm from top and side edges and 250mm from the bottom edge.

Aperture shapes considered herein are rectilinear and as such are permitted unless alternative shapes are detailed within this document for specific glass or glazing systems.

Apertures cannot be rotated (e.g. a square to be rotated to create a diamond effect) unless explicitly stated within this document for specific glass or glazing systems.

Double glazed units must be installed as tested and detailed in section 6.7 below.

Aperture liners are not required by this FoA report but must be installed if required in any referenced Certifire certificate.

#### 6.1.1 Maximum Permitted Glazed Aperture Dimensions

The maximum total assessed aperture area for any individual door leaf based on the test evidence detailed within section 3 is as follows:

<b>Maximum total permitted aperture within the Flamebreak 30 leaf designs</b>		
<b>Maximum Height</b> (mm)	<b>Maximum Width</b> (mm)	<b>Maximum Area</b> (m <sup>2</sup> )
1248	840	0.91

Multiple apertures are acceptable within the permitted total assessed aperture area, with a minimum dimension of 200mm of core between apertures.

Maximum glass thickness permitted is 16mm for single pane glazing.

Minimum glass thickness permitted is 7mm, as tested and may not be reduced, (see section 6.6 for Norsound glazing system options).

The subsequent sections within this report detail the permitted glass and glazing systems with their associated size ranges permitted within the Flamebreak 30 designs.

The maximum glazed areas given in each subsection supersede those given above and must be adhered to. However, the dimensional restrictions given above shall not be exceeded under any circumstance.

It is possible to include glass within the door leaf at smaller dimensions than given for any particular glass type or glazing system.

## 6.2 Certifire Single Pane Glass and Glazing System Options

Alternative glass and glazing systems with a Certifire certificate – valid at the date of manufacture of the doorset which has been written in accordance with Warringtonfire Testing & Certification Ltd, Technical Schedule TS25 - may be used to glaze the Flamebreak 30 designs, subject to the following.

- The minimum thickness of glass permitted for alternative glass types is 7mm.
- The maximum thickness of glass permitted for alternative glass types is 16mm.
- Where a Certifire certificate is utilised to justify glazing the doorset, the full requirements given within that certificate for the glass and glazing system specified must be complied with.
- All parameters in section 6.1 above must take precedence over those in the supporting Certifire certificate, e.g. the glazed area, maximum height and width permitted in section 6.1 above may not be increased on the basis of the area, height and width permitted within the Certifire certificate. If the area, height and width in the proposed Certifire certificate is smaller than that in section 6.1, the smaller dimension will take precedence for the proposed glass or glazing system.
- The general requirements within the proposed Certifire certificate are still applicable, a reference to a previously tested or approved 30 minute fire resisting, 44mm thick door as assessed herein.
- Where the Certifire certificate requires a timber aperture liner, these must always be fitted.
- Bead fixings – The required pin or screw specification as given in the supporting Certifire certificate must be used, alternatives fixing details are not permitted.

## 6.3 Tested Glazing Systems

The tested glass and glazing systems may also be used, subject to the limitations and scope presented above.

### 6.3.1 Pyroshield 2 and Sealmaster Fireglaze

Within test RF08100, Sealmaster Fireglaze intumescent mastic was used as the glazing system combined with Pilkington UK Ltd Pyroshield glass. This combination of materials is supported within Certifire certificate CF221. The pane dimensions permitted within CF221 are smaller than those permitted in section 6.1, however, based on the direct test evidence in RF08100, the pane sizes in section 6.1 may take precedence over those in CF221, only when Pyroshield is used in combination with the Sealmaster Fireglaze intumescent mastic. For all other glass types, the requirements of CF221 must take precedence, as stated in section 6.2.

### 6.3.2 AGC Pyrobelite and Sealed Tight Solutions STS 104SG

The testing conducted on Pacific Rim Wood Ltd. Flamebreak 30 designs has demonstrated that they are capable of tolerating glazed apertures, whilst providing a margin of over performance, as specifically supported by test evidence in WF535889.

Glazing using the tested AGC Pyrobelite7 and Pyrobelite 9EG glass types and the Sealed Tight Solutions STS 104SG glazing system is therefore acceptable within the following parameters.

Apertures must not be less than 100mm from top, 150mm from the side and 450mm from the bottom edge.

Aperture shapes considered herein are rectilinear and as such are permitted unless alternative shapes are detailed within this document for specific glass or glazing systems.

Apertures cannot be rotated (e.g. a square to be rotated to create a diamond effect) unless explicitly stated within this document for specific glass or glazing systems.

An aperture liner is not required.

#### 6.3.2.1 Maximum Permitted Glazed Aperture Dimensions

The maximum total assessed aperture area for any individual door leaf based on WF535889 using the tested AGC Pyrobelite7 and Pyrobelite 9EG glass types and the Sealed Tight Solutions STS 104SG glazing system only is as follows:

<b>Maximum total permitted aperture within the Flamebreak 30 leaf designs</b>		
<b>Maximum Height</b> (mm)	<b>Maximum Width</b> (mm)	<b>Maximum Area</b> (m <sup>2</sup> )
1687	487	0.71

Multiple apertures are acceptable within the permitted total assessed aperture area, with a minimum dimension of 200mm of core between apertures.

Glazing must be constructed using the tested AGC Pyrobelite7 and Pyrobelite 9EG glass types and the Sealed Tight Solutions STS 104SG glazing system only.

It is possible to include glass within the door leaf at smaller dimensions than given for any particular glass type or glazing system.

### 6.3.3 AGC Pyrobelite and Sealed Tight Solutions STS 104SG

The testing conducted on Pacific Rim Wood Ltd. Flamebreak 30 designs has demonstrated that they are capable of tolerating glazed apertures, whilst providing a margin of over performance, as specifically supported by test evidence in WF535889.

Glazing using the tested AGC Pyrobelite7 and Pyrobelite 9EG glass types and the Sealed Tight Solutions STS 104SG glazing system is therefore acceptable within the following parameters.

Apertures must not be less than 100mm from top, 150mm from the side and 450mm from the bottom edge.

Aperture shapes considered herein are rectilinear and as such are permitted unless alternative shapes are detailed within this document for specific glass or glazing systems.

Apertures cannot be rotated (e.g. a square to be rotated to create a diamond effect) unless explicitly stated within this document for specific glass or glazing systems.

An aperture liner is not required.

#### 6.3.3.1 Maximum Permitted Glazed Aperture Dimensions

The maximum total assessed aperture area for any individual door leaf based on WF535889 using the tested AGC Pyrobelite7 and Pyrobelite 9EG glass types and the Sealed Tight Solutions STS 104SG glazing system only is as follows:

Maximum total permitted aperture within the Flamebreak 30 leaf designs		
Maximum Height (mm)	Maximum Width (mm)	Maximum Area (m <sup>2</sup> )
1687	487	0.71

Multiple apertures are acceptable within the permitted total assessed aperture area, with a minimum dimension of 200mm of core between apertures.

Glazing must be constructed using the tested AGC Pyrobelite7 and Pyrobelite 9EG glass types and the Sealed Tight Solutions STS 104SG glazing system only.

It is possible to include glass within the door leaf at smaller dimensions than given for any particular glass type or glazing system.

### 6.4 Pneumatically Fired Pins – Glazing Pins for Glazing Within the Leaf

The following pin specification is permitted and has been considered suitable for applications where a pin fixing is permitted for glazing beads:

#### Option 1 – Round, Oval & Rectangular Pins

The following dimension of pin has been approved for round, oval and rectangular shaped pins which are hand applied:

- Minimum Standard Wire Gauge (SWG) 16.
- Minimum cross section area of 2.03mm<sup>2</sup>.
- Minimum linear dimension of 1.6mm in any direction, see figure below. The maximum pin diameter or any linear dimensions may be no greater than 2.0mm.



### Option 2 – Gun (Pneumatically) Fired Rectangular Pins

The following dimension of rectangular pin has been deemed suitable for gun (pneumatically) fired applications.

- Minimum Standard Wire Gauge (SWG) 16.
- Minimum cross section area of 2.24mm<sup>2</sup>.
- Minimum linear dimensions as shown in the figure.
- The 1.6mm dimension is predominately oriented perpendicular to the glass, where possible.
- The maximum pin diameter or any linear dimensions may be no greater than 2.0mm.

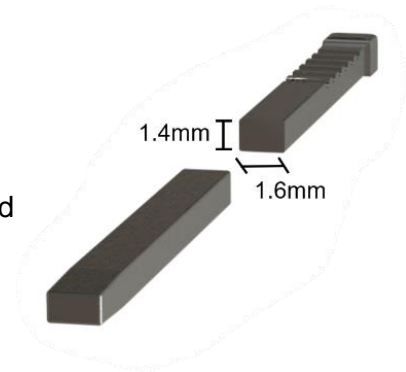

Pins with dimensions less than those stated above are not covered by this assessment.

## 6.5 Improved Security Bead

A combined bead and aperture lining can be used to deny access to fixings from one side of the door leaf to improve security. The enhanced security bead has been assessed as acceptable by Warringtonfire to be suitable since the glass and glazing system and beading is based on a standard chamfered bolection bead but with an integral liner which if anything would be expected to provide enhanced protection to the glazing pocket.

All glazing details are to meet the specification given in sections 6.1 and 6.2 unless otherwise stated below.

The aperture in the door must be lined using minimum 26mm thickness combined bead and lining in hardwood of minimum 640kg/m<sup>3</sup> density.

The combined bead and lining must be bonded to the aperture in the door using the adhesive types approved for lippings (see section 9) and reinforced using No. 6 – 8, 50mm long screw fixings located centre thickness of the door at 200mm centres.

The beads must additionally be retained in position with 50mm long steel pins or 50mm long No. 6 - 8 screws, inserted at 35 - 40° to the vertical. Fixings must be at 150mm maximum centres and no more than 50mm from each corner. Pneumatically fired pins are acceptable providing the pins meet the specification given in section 6.4 above. The bead profile must be appropriate for the glazing system selected.

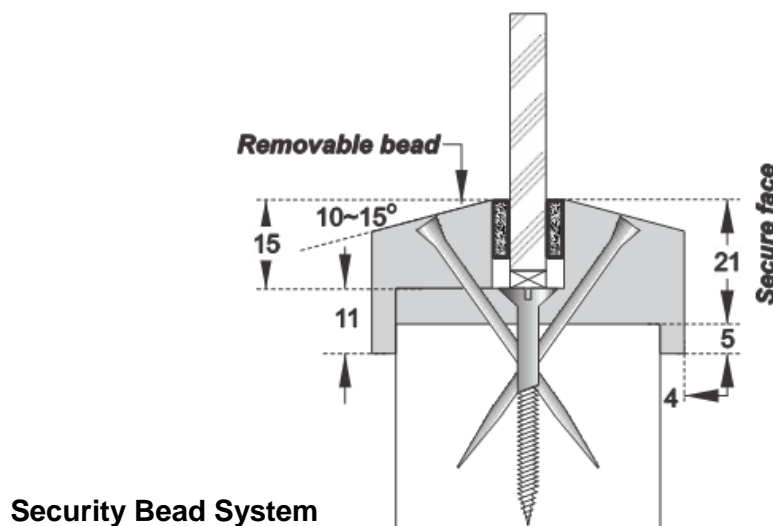

## 6.6 Norsound Single Pane Glass & Glazing Systems – Leaf types 1 – 6

### 6.6.1 Norsound Ltd. – Norsound Universal 30B

The Norsound Ltd. Universal 30B glazing system has the following scope of application in addition to that described in sections 6.1 & 6.2.

The Norsound Universal 30B is illustrated below:

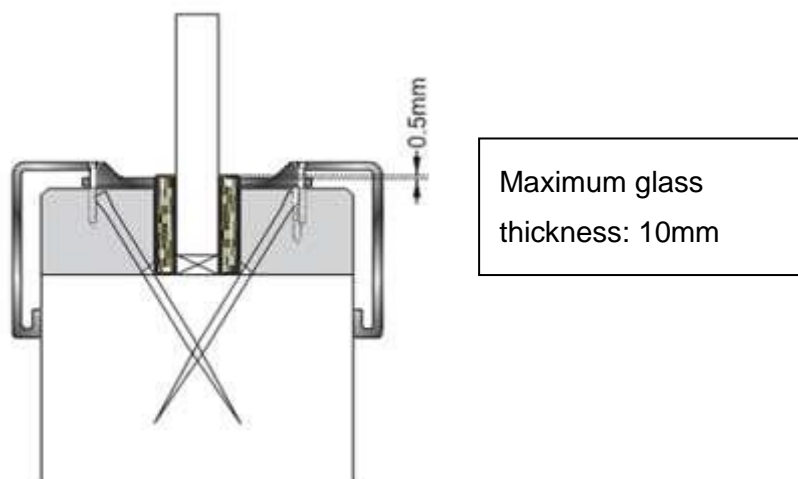

#### 6.6.1.1 Norsound Universal 30B Installation Notes

1. Bead height must be nominally 13mm.
2. The intumescent seal component of Norsound Universal 30B is 15mm high and is required to project 0.5mm above the sightline of the aluminium cladding fixed over the glazing bead.
3. Glazing beads must be retained in position with minimum 40mm long x 1.5mm diameter steel pins, or minimum 40mm long No. 6 – 8 screws, inserted at 35 – 40° to the vertical, at no more than 40mm from each corner and at 150mm maximum centres.
4. Pneumatically fired pins are acceptable providing the pins meet the specification given in section 6.4 above.
5. The Norsound Universal aluminium section cladding the timber bead must be secured to the core bead by using 3No. 10 – 12mm No.4 grub screws per length.

The bead material and permitted glass types must meet the following specification.

Material	Min. Density (kg/m <sup>3</sup> )	Permitted Glass Types
Straight grained, joinery quality softwood or hardwood, free from knots, splits, and checks	450	All in section 6.6.3
MDF	700	



## 6.6.2 Norsound Ltd. – Norsound Vision 30B

The Norsound Ltd. glazing system tested in IF12011 has the following scope of application in addition to that described in sections 6.1 & 6.2.

The Norsound Vision 30B is illustrated below.

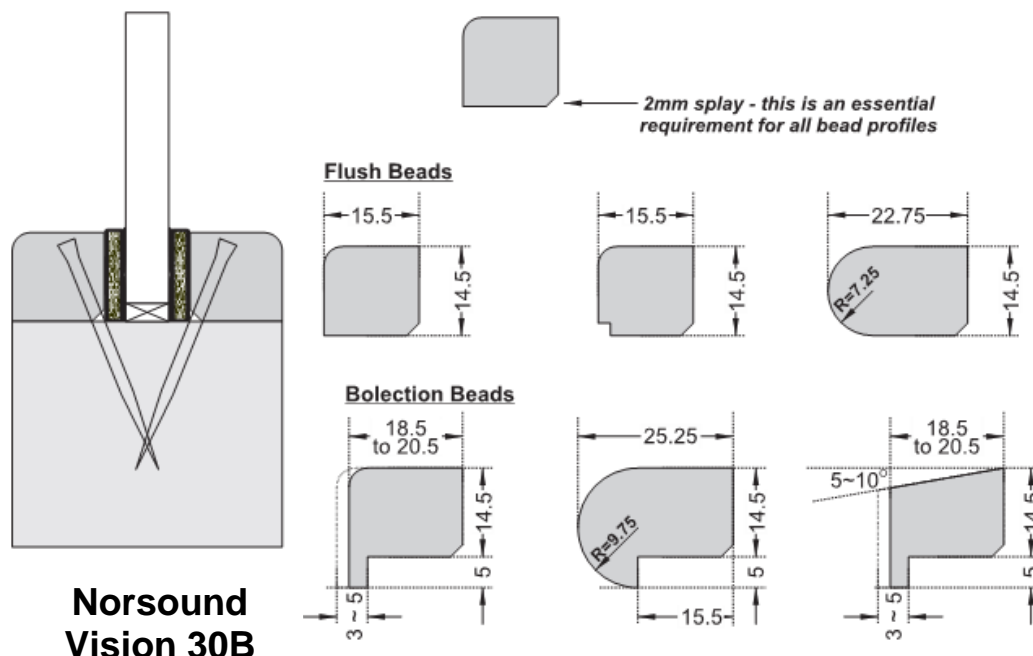

**Norsound  
 Vision 30B**

### Alternative Bead Profiles

**Note:** When used with flush beads the maximum approved glass thickness is 8mm.

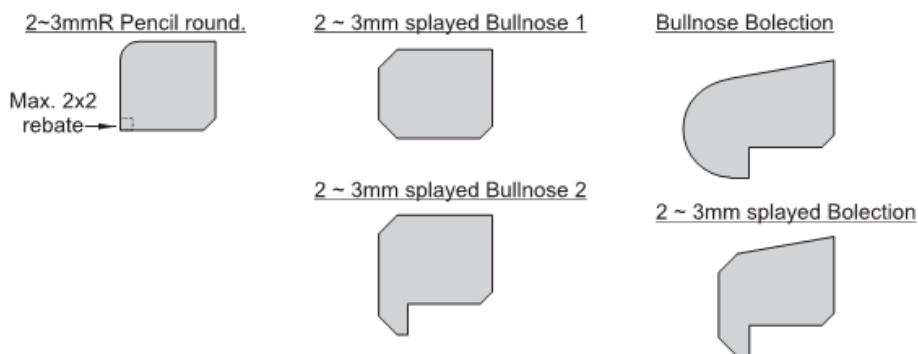

### Notes:

1. Bead height must be nominally 14.5mm
2. The intumescent seal component of Norsound Vision 30B is 15mm high and is required to project 0.5mm above the sightline of the bead.
3. Beads must incorporate a bolection return. Bolection returns should be a minimum of 5mm high, and a minimum of 3mm thick (projecting from the leaf face)
4. Glazing beads must be retained in position with, minimum, 40mm long steel pins or, minimum, 40mm long No. 6-8 screws, inserted at 35-40° to the vertical at no more than 40mm from each corner and at 150mm maximum centres.
5. Pneumatically fired pins are acceptable providing the pins meet the specification given in section 6.4.
6. The bead type and permitted glass types must meet the following specification.

Bead Shape	Material	Minimum Density (kg/m <sup>3</sup> )	Permitted Glass Types
Square & flush	Straight grained, joinery quality softwood or hardwood, free from knots, splits, and checks	510	All in section 6.6.3
	MDF	700	
Bolection	Straight grained, joinery quality softwood or hardwood, free from knots, splits, and	510	
	MDF	700	

### 6.6.3 Permitted Glass Types

The table below specifies the permitted glass types for use with the Norsound glazing systems. The total area of all glazed apertures must not exceed that state in Section 6.1 above.

Option	Glass Type and Manufacturer	Glass Thickness (mm)
1	Pyroshield 2 - Clear Pilkington UK Ltd <sup>2</sup> (RF08001)	6 & 7
2	Pyran S Schott Glass Ltd (CF291)	6
3	Pyrostem Pyroguard UK Ltd (CF257)	6
4	Pyrobelite 12 AGC Flat Glass UK (CF377)	12
5	Pyrodur 30-104/105 <sup>1</sup> Pilkington UK Ltd <sup>4</sup> (CF377)	7
6	Pyrodur 60-10 Pilkington UK Ltd (CF328)	10

#### Notes:

1. Pyrodur 30-104 and 30-105 may be freely interchanged whilst having the same scope of application, in fire resistance terms, herein. The two products have different impact resistance rating, contact Pilkington UK Ltd for details.
2. Pilkington UK Ltd Pyroshield 2 – Textured glass is not permitted for fire resisting applications.

## 6.7 Double Glazed Units & Glazing Systems – Leaf types 1 & 2 only

The following section provides a scope of approval for the use of the AGC Pyrobelite7 based IGU in Flamebreak door leaves, leaf options 1 and 2 only. Unless stated in the following sections, all construction details for the Flamebreak leaf (options 1 and 2 only) must remain as specified in the main assessment.

The glazing system must be the following tested system from 18-003111-PR04:

### Glazing details.

Glass: IGU comprised of 7mm(t) Pyrobelite/8mm(t) steel spacer/6.8mm(t) laminate glass, the Pyrobelite must be oriented to the fire risk side

25 (w) x 16mm (h) with a 5 x 5mm bolection return hardwood beads (minimum density 640kg/m<sup>3</sup>). The bead shape may be square topped or incorporate a 10 – 15° chamfer.

Beads must be retained with 50mm long steel pins at maximum of 50mm from corners and 150mm centres inserted at 30° to the plane of the glass.

STS 105GT located between the glass and the beads with a ST302 liner around all 4 sides of the aperture.

2mm high x 20mm wide x 25mm long hardwood or non-combustible setting blocks with 2mm expansion allowance to all edges

Maximum glazed area is 0.19m<sup>2</sup>

Multiple panes are permitted within the maximum area above with a minimum of 200mm between apertures.

## 7 Door Frame Construction

### 7.1 Details for Frame 1 & 2

The door frames listed below are the minimum size and density which have been successfully tested and assessed by this report. The frame must be constructed to meet the following specification for single and double acting frames, where applicable.

Frame Type	Material <sup>3</sup>	Minimum Section Size (mm)	Minimum Density (kg/m <sup>3</sup> )	Acceptable Leaf Type
1	Softwood / Hardwood <sup>3</sup>	Frame: 70 (d) x 32 (t) (excluding stop) Stop: 12 (h) (integral or planted on)	450	All types 1 - 6
2	MDF	Frame: 70 (d) x 30 (t) (excluding stop) Stop: 12 (h) (integral or planted on)	750	

### Notes:

1. Minimum section size is subject to size of hardware and the use of transomed overpanel (see frame details below)
2. All door frame timber must meet or exceed class J30 as specified in BS EN 942: 2007 (subject to adequate repair of any defects)
3. The timber element must be made from a continuous solid piece, finger jointed or laminated 'engineered' timber is not permitted.
4. Rounded or rebated quirk edges to door frames are not permitted.

### 7.1.1 Standard frame detail

The diagram below shows detail of the standard frame construction. Minimum section is permitted in two sizes subject to hardware size and the use of transom overpanel. Any radius to the lipping must comply with section 5.2.3.

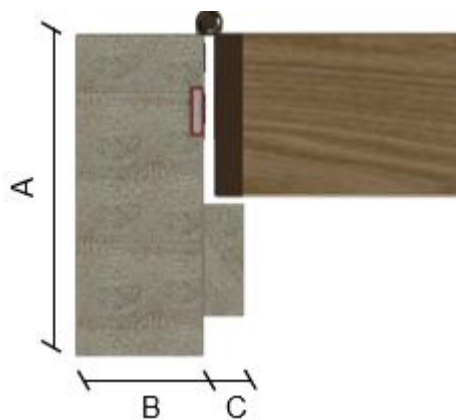

- A: Frame depth = 70mm minimum
- B: Frame thickness = 30 -32mm minimum
- C: Stop height = 12mm minimum

Minimum section size when using a transomed overpanel - **the use of frame type 2 is not permitted:**

- A: Frame depth = 70mm minimum
- B: Frame thickness = 32mm minimum
- C: Stop height = 12mm minimum

### 7.1.2 Scalloped frame detail

The diagram below shows detail of the scalloped frame construction hanging edge only. When using scalloped frames for double acting doorsets, the groove for the specified intumescent strips must be as shown below and to the correct depth.

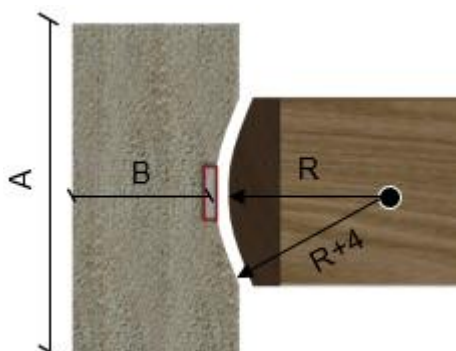

- A: Frame depth = 70mm minimum
- B: Frame thickness = 30 - 32mm minimum
- R: Radius from floor spring or pivot = 8mm maximum to create a maximum 2mm edge profiling

### 7.1.3 Square frame detail for double acting doorsets

The diagram below shows detail of the square frame construction for the closing edge of a double acting doorset. Where utilising square frames for double acting doorsets, any radius to the lipping must comply with section 5.2.3.

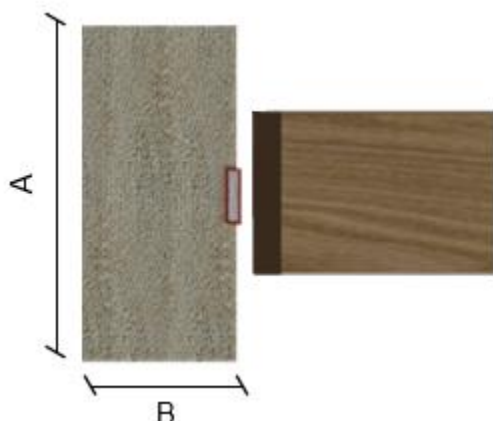

- A: Frame depth = 70mm minimum
- B: Frame thickness = 30 - 32mm minimum

## 7.2 Threshold

### 7.2.1 Stormguard Slimline

Test reference 18-003111-PR04 incorporated the Stormguard Slimline protected with ST302 graphite liner fitted to the upper face of the threshold.

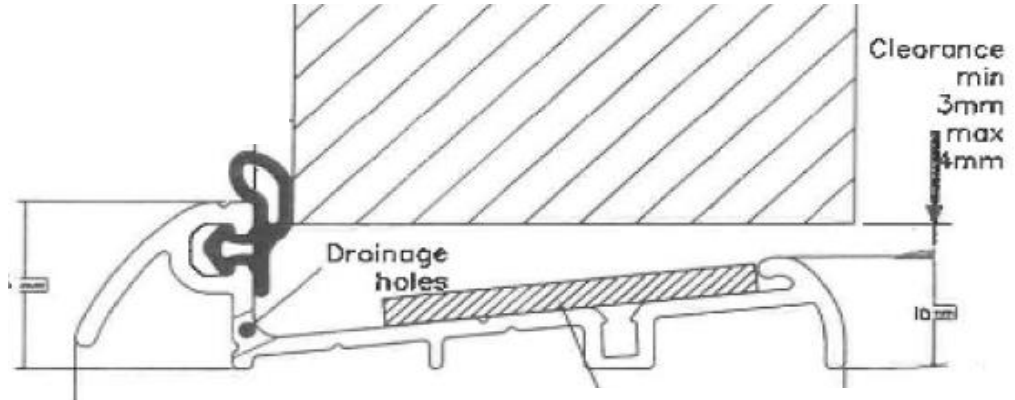

62mm wide Stormguard Slimline      ST302 graphite

### 7.2.2 Timber Threshold

Test reference WF504980 incorporated a hardwood timber threshold.

Timber thresholds are therefore permitted subject to the following:

- The threshold must be hardwood of minimum density 640kg/m<sup>3</sup>.
- The threshold must be of dimensions A: 45 - 60mm thick x 100 – 150mm wide with a 15mm high integral stop as shown.
- Threshold must be butt jointed to the frame jambs.
- A Pyroplex 8712 brush seal must be self-adhesive fixed to the bottom edge of the leaf.
- The gap between the bottom of the leaf and top of the threshold must be controlled to a maximum of 5mm.

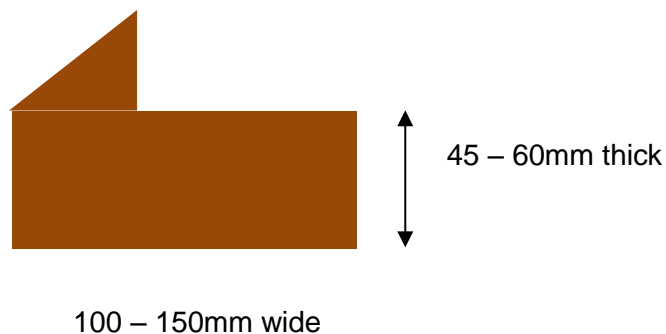

### 7.3 Door Frame Joints

Below are depictions of the door framing joints that are deemed acceptable. Please note that the drawings are provided as general illustrations of each type of door frame joint; actual construction in terms of intumescent seal location and material, etc. must be as the text within this document specifies. The door frame joints are required to be tight, with no gaps, and require mechanical fixing with the appropriate size ring shank nails or screws. Frame joints may additionally be reinforced with any of the adhesives approved for the application of lippings, on the basis that the approved lipping adhesive has been proven to contribute to the positive fire resistance performance of the timber to timber junction at the door leaf edge.

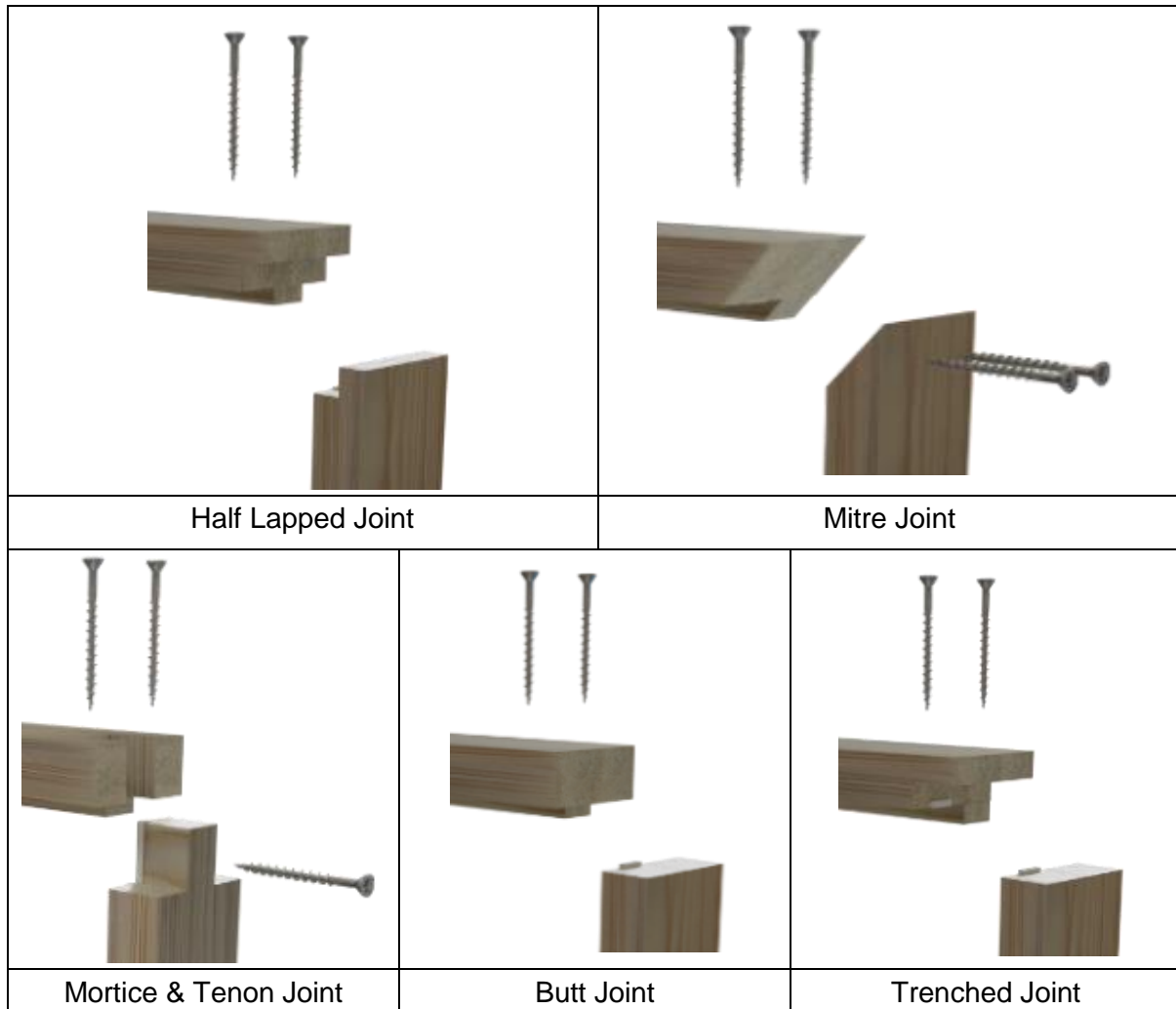

## 7.4 Decorative Facings – All Frame Options

Relatively thin facing materials are deemed to be decorative, and their application is not considered to be of detriment to the overall stability or performance of the doorset design.

The following additional facing materials are therefore permitted to the frame for this door design, including frame reveal, since they would have limited influence under fire resistance test conditions.

Decorative & Protective Facing Specification	
Facing Material	Maximum Permitted Thickness (mm)
Paint <sup>3</sup>	0.2
Timber veneers	0.7

### Notes:

1. Facing materials not listed above are not permitted.
2. For all options, materials must not conceal intumescent strips.
3. Intumescent paints are not permitted.

Decorative finishes listed above may be painted within the limits for paint finish in note 1 above.

## 8 Overpanels & Fanlights & Sidelights

Overpanels, fanlights and sidelights are permitted based on the testing as summarised within section 3, the following sections outline the constructional details of each of the permitted elements and limitations associated with each configuration.

The overall assembly shall form a rectilinear shape.

### 8.1 General

The testing undertaken on the doorset design allows for the application of:

Solid overpanels with three framing options (Modular, Transomed & Flush).

Solid sidepanels with one framing option (Modular).

Glazed fanlights with one framing option (Modular).

Glazed sidelights with one framing option (Modular).

Framing options are detailed in the following section depending on the panel or glazing utilised, which takes precedence over the details for frame types 1 and 2 details in section 7.

### 8.2 Framing

The framing options as detailed below are permitted for the doorset design and are permitted depending on solid panel arrangement or glazed fanlight / sidelight utilised. Information on the frame type permitted for the solid panel or glazed element is detailed in sections 8.2.1 - 8.2.3.

#### 8.2.1 Modular Framing

Modular framing for the purpose of this document is considered to be an element (glazing or panel) which is independently framed and fixed to the frame of a doorset design. An example of a modular framed solution is given below. This is supported for use in this assessment by test WF535889.



**Single leaf doorset with glazed modular sidelight.**

### 8.2.1.1 Standard Frame Detail (Modular Framing)

The frame listed below is the minimum size and density which has been successfully tested and assessed by this report. The frame must be constructed to meet the following specification for modular units containing solid panels or glazing, the frame section shall meet this specification on all four edges.

Material	Minimum section size (mm)	Minimum density (kg/m <sup>3</sup> )
Softwood or Hardwood: (see section 2.1).	Frame: 70 (d) x 30 (w)	510

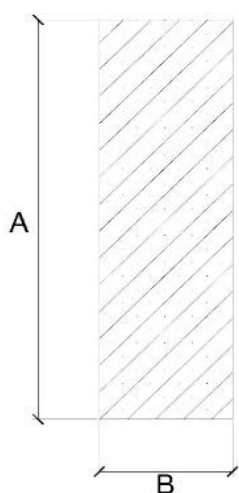

A: Frame depth = 70mm minimum

B: Frame width = 30mm minimum

#### Notes:

It is possible to include a 3mm x 3mm quirk detail to the rear edges of the frame where the jointing to the door frame or adjacent modular framing element shall occur.

The depth of the modular frame and the door frame shall be equal, this may result in increasing the depth of the permitted door frame to match the modular frame dimension, or vice versa. In all cases the greater dimension shall be used.



### 8.2.1.2 Frame Jointing (Modular Framing)

Below are depictions of the framing joints that are deemed acceptable for corner jointing of modular framing. Please note that the drawings are provided as general illustrations of each type of frame joint; actual construction in terms of intumescent seal location and material, etc. must be as the text within this document specifies.



Double Rebated Joint



Mitre Joint



Mortice & Tenon Joint



Butt Joint



Trenched or Half Lapped Joint

The modular frame joints are required to be tight, with no gaps, and require mechanical fixing with 2No. Ø5mm x 70mm steel screws.

### 8.2.1.3 Attachment Technique (Modular Framing)

The modular framing shall be affixed to the door frame or adjacent modular framed units utilising steel screws appropriate for use with timber substrates.

Screws must be fixed at 50mm from corners and at a maximum of 388mm centres between fixings on the centre line of the framing. Fixings shall penetrate approximately half of the depth of the adjacent timber section.

2 No grooves, 15mm wide x 4mm deep must be rebated into the rear of the modular framing. The grooves must be infilled with Mann McGowan Pyromas A intumescent mastic prior to fixing against door frame elements. Not required where modular framing is fixed directly to the supporting construction, in which case firestopping details as given in section 11 must be used.

### 8.2.2 Shared framing (Transomed)

Shared framing (transomed), for the purpose of this document, is considered to be when an element (panel) is contained within the frame for the doorset and separated from the door leaf by a shared transom. An example of a transomed solution is given below, though the construction of doorsets shall be as the text in this document specifies.



#### 8.2.2.1 Standard Frame Detail (Transomed)

The permitted frame detail for the doorset shall meet the minimum requirements as outlined in section 7.1, where applicable. The detail for the permitted transom can be found within section 8.2.2.2 below.

### 8.2.2.2 Detail for Transom (Transomed)

It is possible to include a transom to separate a panelled overpanel within a door frame from the door leaf. It is not permitted to include a mullion within a doorset which is constructed using the shared framing design. When applied the transom shall meet the following specification:

Modular Frame specification		
Frame Type	Minimum section size (mm)	Minimum density (kg/m <sup>3</sup> )
Frame 1	Transom: 70 (d) x 32 (w)	450
Frame 2	Not Permitted	

#### Notes:

When applied, the material for the transom shall match the timber species used for the frame surrounding the door frame.

#### Minimum Section Size – Frame 1



A: Transom depth = 70mm minimum

B: Transom thickness = 32mm minimum

### 8.2.2.3 Frame Jointing (Transomed)

Below are depictions of the framing joints that are deemed acceptable for corner jointing of transomed framing. Please note that the drawings are provided as general illustrations of each type of frame joint; actual construction in terms of intumescent seal location and material, etc. must be as the text within this document specifies.



Mortice & Tenon Joint



Butt Joint

The transom when applied shall be mortice and tenon or butt jointed as depicted above. The joints are required to be tight, with no gaps, and require mechanical fixing with 2No. appropriate size, steel ring shank nails or screws.

- Joints are required to be tight, with no gaps, and require mechanical fixing with the appropriate size ring shank nails or screws.

### 8.2.3 Solid Panel Construction (Side or Over Panels)

Based on the testing undertaken on the doorset design, it has been assessed to include the tested core construction as a solid fixed panel. This is because under test conditions the panel will be fixed within the perimeter framing limiting the deflection throughout the test duration and enhancing the expected fire resistance performance which was observed for the door leaf itself. Therefore, the following specification shall be met:

**Note:** Permitted leaf types to manufacture overpanels are limited to types 1 to 4 only.

The panel must always be lipped as specified in section 5.2.3, and the panel shall be constructed of a single board, joints are not permitted within any panels.

The minimum panel thickness after calibration is 43mm (i.e. a maximum of 0.5mm from both sides).

Decorative & protective facings may be applied to the surface of the solid panels in accordance with section 5.3.1.1.

The minimum panel thickness after finishes applied is 44mm.

Table below specifies the maximum assessed solid overpanel dimensions whether transomed or flush/rebated.

Assembly Element		Height (mm)	Width (mm)
Overpanel	Single Doorsets	1500	Overall doorset width
	Double Doorsets	1000	Overall doorset width
Sidepanel – modular framing only	Single and Double Doorsets	Up to maximum dimension given in section 4.5 for leaf size based on intumescent specification used.	

### 8.2.4 Flush Overpanels

Doorsets with flush/rebated overpanels of the same construction as the door leaves have been successfully tested in report reference RF08118.

The solid flush and rebated panel designs given permitted herein have therefore been provided based upon the successful testing undertaken.

- For flush overpanel configurations the door leaves and overpanel must be constructed using 4mm plywood faced Flamebreak 430 (leaf type 1) only.
- Overpanels and door leaf/leaves and must be lipped on all edges. The overpanel must be fully contained within the door frame with respect to frame thickness.
- Flush overpanels must always be lipped on the bottom edge of the overpanel and top edge of the leaf.

### **8.2.5 Intumescent Sealing Arrangement (Side or Over Panels)**

Solid panels when included within a doorset design shall include the same intumescent specification as utilised within the door leaf or frame reveal.

Solid flush overpanels shall include the intumescent specification as detailed within sections 4.5.5.9 – 4.5.5.12 as applicable.

Permitted intumescent specifications are detailed in section 4.5, while there may be multiple options for manufacturer and seal types only one specification can be utilised with any single doorset, and the specification used shall match the specification used on the door leaf.

### **8.2.6 Fixing Arrangement (Panels)**

Solid panels must be fixed into the framing solution by steel screws appropriate for the timber-based substrates.

Screws shall be applied nominally centrally to the thickness of the solid panel, through the rear of the frame to all edges and transom reveal where applicable and shall penetrate into the solid panel by at least 30mm.

Fixings must be no more than 100mm from each corner and a maximum of 250mm centres in between.

When fitted the solid panel shall have no greater than 1mm between the panel edge and the adjacent framing element.

Where fitted within shared framing (transomed) the face of the solid overpanel shall be nominally in line with the face of the door leaf.

Where fitted in a flush arrangement the face of the solid overpanel shall be in line with the face of the door leaf.

## **8.3 Glazed Fanlights & Sidelights**

Based on the testing detailed within section 3, it has been possible to consider the use of glazed fanlights and sidelights.

### **8.3.1 Tested and Assessed Glass types & Glazing Systems**

The following sections provide a scope of approval for different glass types when used for glazing fanlights or side screens. Fanlights may be used in conjunction with side screens subject to the specification given for each of the glass types.

Unless stated in the following sections, all construction details for the Flamebreak doorset must remain as specified in the main assessment.

### 8.3.2 Pyroguard EW30 (7mm thick) – Pyroguard UK Ltd.

Based on test data contained within RF10070, the following specification is permitted:

#### Transom/mullion details.

- Minimum 75mm deep x 40mm thick softwood or hardwood (minimum density 510kg/m<sup>3</sup>). This timber section can be used for both door jambs and transoms above doors included within screens and for the perimeter framing of the screen and the transoms and mullions separating individual panes of glass within the fanlights and side screens.

#### Glazing details.

- 15mm high x 32mm deep hardwood beads (minimum density 640kg/m<sup>3</sup>). The bead shape may be square or incorporate a 10 – 15° chamfer.
- 50mm long No. 6 - 8 steel wood screws at maximum of 70mm from corners and 200mm centres inserted at 30° to the plane of the glass.
- 10mm x 2mm Interdens located between the glass and the beads.
- 5mm high x 7mm wide x 40mm long hardwood or non-combustible setting blocks with 5mm expansion allowance to all edges.

#### Maximum single pane dimensions.

Screen Element		Height (mm)	Width (mm)
Fanlight	From:	1074	808
	To:	808	2600
Side screen		2500	1000

- The pane dimensions given above represent the maximum permitted width against maximum permitted height. Panes with smaller dimensions are acceptable.
- Transoms supporting single panes above 900mm wide must be centrally supported by at least one vertical mullion.

#### Multiple panes.

- The fanlights and side screens may comprise multiple panes of glass providing the total doorset and screen assembly does not exceed 2950mm high and the transom/mullion restrictions above are complied with.

#### Leaf configurations and screen dimensions:

- The total width of the screen assembly is unlimited.
- The screen assembly may only contain 1No. single or double leaf doorset.

### 8.3.3 Pyroguard EW30 MAXI (11mm thick) – Pyroguard UK Ltd.

Based on test data contained within RF10163, the following specification is permitted.

#### Transom/mullion details.

- Minimum 75mm deep x 40mm thick hardwood (minimum density 640kg/m<sup>3</sup>). This timber section can be used for both door jambs and transoms above doors included within screens and for the perimeter framing of the screen and the transoms and mullions separating individual panes of glass within the fanlights and side screens.

#### Glazing details.

- 20mm high x 30mm deep hardwood beads (minimum density 640kg/m<sup>3</sup>). The bead shape may be square or incorporate a 10 - 15° chamfer.
- 50mm long No. 6 - 8 steel wood screws at maximum of 70mm from corners and 200mm centres inserted at 30° to the plane of the glass.
- 10mm x 2mm Interdens located between the glass and the beads.
- 5mm high x 11mm wide x 40mm long hardwood or non-combustible setting blocks with 5mm expansion allowance to all edges.

#### Maximum single pane dimensions.

Screen Element		Height (mm)	Width (mm)
Fanlight	From:	967	2525
	To:	808	3000
Side Screen		2700	1500

- The pane dimensions given above represent the maximum width against maximum height. Panes with smaller dimensions are acceptable.

#### Multiple panes.

- The fanlights and side screens may comprise multiple panes of glass providing the total doorset and screen assembly does not exceed 2950mm high and the transom/mullion restrictions above are complied with.

#### Leaf configurations and screen dimensions:

- The total width of the screen assembly is unlimited.
- The screen assembly may only contain 1No. single or double leaf doorset.

### 8.3.4 Pyroguard EI30 (15mm thick) – Pyroguard UK Ltd.

#### Transom/mullion details.

- Minimum 80mm deep x 40mm thick hardwood (minimum density 640kg/m<sup>3</sup>). This timber section can be used for both door jambs and transoms above doors included within screens and for the perimeter framing of the screen and the transoms and mullions separating individual panes of glass within the fanlights and side screens.

#### Glazing details.

- 20mm high x 23mm deep hardwood beads (minimum density 640kg/m<sup>3</sup>). The bead shape may be square or incorporate a 10 - 15° chamfer.
- 50mm long No. 6 - 8 steel wood screws at maximum of 70mm from corners and 200mm centres inserted at 30° to the plane of the glass.
- 7mm x 2mm Egopren glazing tape located between the glass and the beads.
- 15mm x 2mm Kerafix Pan 200 edge seal fitted around edge of glass.
- 3mm high x 15mm wide x 80mm long hardwood or non-combustible setting blocks with 5mm expansion allowance to all edges.

#### Maximum single pane dimensions.

Screen Element	Height (mm)	Width (mm)
Fanlight	350	2890
Side Screen	From:	2520
	To:	1141
		225
		1100

- The pane dimensions given above represent the maximum width against maximum height. Panes with smaller dimensions are acceptable.
- Transoms supporting single panes above 1100mm wide must be centrally supported by at least one vertical mullion.

#### Multiple panes.

- The fanlights and side screens may comprise multiple panes of glass providing the total doorset and screen assembly does not exceed 2950mm high and the transom/mullion restrictions above are complied with.

#### Leaf configurations and screen dimensions.

- The total width of the screen assembly is unlimited.
- The screen assembly may only contain 1No. single or double leaf doorsets.



### 8.3.5 Pyroshield 2 (6mm thick) – Pilkington Group Ltd.

#### Transom/mullion details.

- Minimum 80mm deep x 44mm thick softwood or hardwood (minimum density 510kg/m<sup>3</sup>). This timber section can be used for both door jambs and transoms above doors included within screens and for the perimeter framing of the screen and the transoms and mullions separating individual panes of glass within the fanlights and side screens.

#### Glazing details.

- 15mm high x 20mm deep hardwood beads (minimum density 640kg/m<sup>3</sup>) with an 18° chamfer
- 40mm long No. 6 - 8 steel wood screws at maximum of 50mm from corners and 150mm centres inserted at 45° to the glass.
- 10mm x 2mm Interdens located between the glass and the beads.
- 3mm high x 6mm wide x 40mm long hardwood or non-combustible setting blocks fitted at 300mm centres along bottom edge of glass with 3mm expansion allowance to all edges.

#### Maximum single pane dimensions.

Screen Element	Height (mm)	Width (mm)
Fanlight	810	1830
Side Screen	2040	485

- The pane dimensions given above represent the maximum permitted width against maximum permitted height. Panes with smaller dimensions are acceptable.

#### Multiple panes.

- The fanlights and side screens may comprise multiple panes of glass providing the total doorset and screen assembly does not exceed 2950mm high and the transom/mullion restrictions above are complied with.

#### Leaf configurations and screen dimensions.

- The total width of the screen assembly is unlimited.
- The screen assembly may only contain 1No. single or double leaf doorset.

### 8.3.6 Pyrodur 30-104 (7mm thick) – Pilkington Group Ltd.

Based on test data contained within RF00138, the following specification is permitted.

#### Transom/mullion details.

- Minimum 80mm deep x 44mm thick hardwood (minimum density 640kg/m<sup>3</sup>). This timber section can be used for both door jambs and transoms above doors included within screens and for the perimeter framing of the screen and the transoms and mullions separating individual panes of glass within the fanlights and side screens.

#### Glazing details.

- 20mm high x 20mm deep hardwood beads (minimum density 640kg/m<sup>3</sup>) with a 15° chamfer
- 40mm long No. 6 - 8 steel wood screws at maximum of 50mm from corners and 150mm centres inserted at 30° to the glass.
- 20mm x 2mm Interdens located between the glass and the beads.
- 3mm high x 6mm wide x 40mm long hardwood or non-combustible setting blocks fitted at 300mm centres along bottom edge of glass with 3mm expansion allowance to all edges.

#### Maximum single pane dimensions.

Screen Element	Height (mm)	Width (mm)
Fanlight	810	1670
Side Screen	2057	956

- The pane dimensions given above represent the maximum permitted width against maximum permitted height. Panes with smaller dimensions are acceptable.

#### Multiple panes.

- The fanlights and side screens may comprise multiple panes of glass providing the total doorset and screen assembly does not exceed 2950mm high and the transom/mullion restrictions above are complied with.

#### Leaf configurations and screen dimensions.

- The total width of the screen assembly is unlimited.
- The screen assembly may only contain 1No. single or double leaf doorsets.

### 8.3.7 Pyrodur 60-10 (10mm thick) – Pilkington Group Ltd.

Based on test data contained within RF05036, the following specification is permitted.

#### Transom/mullion details.

- Minimum 80mm deep x 44mm thick hardwood (minimum density 640kg/m<sup>3</sup>). This timber section can be used for both door jambs and transoms above doors included within screens and for the perimeter framing of the screen and the transoms and mullions separating individual panes of glass within the fanlights and side screens.

#### Glazing details.

- 20mm high x 20mm deep hardwood beads (minimum density 640kg/m<sup>3</sup>) with a 15° chamfer
- 40mm long No. 6 - 8 steel wood screws at maximum of 50mm from corners and 150mm centres inserted at 30° to the glass.
- 20mm x 2mm Interdens located between the glass and the beads.
- 3mm high x 6mm wide x 40mm long hardwood or non-combustible setting blocks fitted at 300mm centres along bottom edge of glass with 3mm expansion allowance to all edges.

#### Maximum single pane dimensions.

Screen Element	Height (mm)	Width (mm)
Fanlight	810	1670
Side Screen	2057	956

The pane dimensions given above represent the maximum permitted width against maximum permitted height. Panes with smaller dimensions are acceptable.

#### Multiple panes.

- The fanlights and side screens may comprise multiple panes of glass providing the total doorset and screen assembly does not exceed 2950mm high and the transom/mullion restrictions above are complied with.

#### Leaf configurations and screen dimensions.

- The total width of the screen assembly is unlimited.
- The screen assembly may only contain 1No. single or double leaf doorsets.

### 8.3.8 Pyrostop 30-10 (15mm thick) – Pilkington Group Ltd.

Based on test data contained within RF05037, the following specification is permitted.

#### Transom/mullion details.

- Minimum 95mm deep x 44mm thick hardwood (minimum density 640kg/m<sup>3</sup>). This timber section can be used for both door jambs and transoms above doors included within screens and for the perimeter framing of the screen and the transoms and mullions separating individual panes of glass within the fanlights and side screens.

#### Glazing details.

- 20mm high x 37mm deep hardwood beads (minimum density 640kg/m<sup>3</sup>). Can be square or chamfered.
- 60mm long No. 6 – 8 steel wood screws at maximum of 50mm from corners and 150mm centres inserted at 45° to the glass.
- 12mm x 3mm Hodgsons Sealants Firestrip 30 located between the glass and the beads.
- 5mm high x 15mm wide x 40mm long hardwood or non-combustible setting blocks fitted at 300mm centres along bottom edge of glass with 5mm expansion allowance to all edges.

#### Maximum single pane dimensions.

Screen Element	Height (mm)	Width (mm)
Fanlight	733	1001
Side Screen	2870	1366

- The pane dimensions given above represent the maximum permitted width against maximum permitted height. Panes with smaller dimensions are acceptable.

#### Multiple panes.

- The fanlights and side screens may comprise multiple panes of glass providing the total doorset and screen assembly does not exceed 2950mm high and the transom/mullion restrictions above are complied with.

#### Leaf configurations and screen dimensions.

- The total width of the screen assembly is unlimited.
- The screen assembly may only contain 1No. single or double leaf doorset.

### 8.3.9 Pyrobelite 7 (7mm thick) – AGC Glass UK Limited.

Based on test data contained within WF535889, the following specification is permitted for Pyrobelite 7 for fanlights only.

#### Framing details.

- Minimum 70mm deep x 30mm thick softwood (minimum density 510kg/m<sup>3</sup>). This timber section can be used for the perimeter framing of the screen.
- Sidelights and fanlights glazed using Pyrobelite 7 must be installed within modular (4 sided) framing as detailed in section 8.2.1.
- The use of mullions within fanlights is not permitted.

#### Glazing details.

- 15mm high x 20mm deep hardwood beads (minimum density 600kg/m<sup>3</sup>) with a 15° chamfer
- 31mm long x 3.6mm diameter steel wood screws at maximum of 70mm from corners and 200mm centres inserted at 15° to the glass.
- STS 104SG located between the glass faces and the beads.
- 3mm high x 6mm wide x 40mm long hardwood or non-combustible setting blocks fitted at 300mm centres along bottom edge of glass with 3mm expansion allowance to all edges.

#### Maximum single pane dimensions.

As tested in WF535889, fanlights constructed to the requirements of this section (8.3.9) may oversail the joint between a door set and sidelight or sidepanel.

Screen Element	Height (mm)	Width (mm)
Fanlight	675	2732

The pane dimensions given above represent the maximum permitted width against maximum permitted height. Panes with smaller dimensions are acceptable.

#### Multiple panes.

- Multiple panes are not permitted in fanlights.

#### Leaf configurations and screen dimensions.

- The total width of the screen assembly is limited to 2732mm as shown above.
- The screen assembly may only contain 1No. single or double leaf doorsets.

### 8.3.10 Pyrobelite 9EG (9mm thick) – AGC Glass UK Limited.

Based on test data contained within WF535889, the following specification is permitted for Pyrobelite 9EG for sidelights only.

#### Framing details.

- Minimum 70mm deep x 30mm thick softwood (minimum density 510kg/m<sup>3</sup>). This timber section can be used for the perimeter framing of the screen and any horizontal mullions separating individual panes of glass within side screens.
- Sidelights and fanlights glazed using Pyrobelite 9EG must be installed within modular (4 sided) framing as detailed in section 8.2.1.

#### Glazing details.

- 15mm high x 20mm deep hardwood beads (minimum density 600kg/m<sup>3</sup>) with a 15° chamfer
- 31mm long x 3.6mm diameter steel wood screws at maximum of 70mm from corners and 200mm centres inserted at 15° to the glass.
- STS 104SG located between the glass faces and the beads.
- 3mm high x 6mm wide x 40mm long hardwood or non-combustible setting blocks fitted at 300mm centres along bottom edge of glass with 3mm expansion allowance to all edges.

#### Maximum single pane dimensions.

Screen Element	Height (mm)	Width (mm)
Sidelight	2220	550

The pane dimensions given above represent the maximum permitted width against maximum permitted height. Panes with smaller dimensions are acceptable.

#### Multiple panes.

- Sidelights may comprise multiple panes of glass providing the total doorset and screen assembly does not exceed 2950mm high and the transom/mullion restrictions above are complied with.
- The sidelight may not be higher than the door frame.

#### Leaf configurations and screen dimensions.

- The total width of the screen assembly is unlimited.
- The screen assembly may only contain 1No. single or double leaf doorsets.

## 9 Adhesives

The following adhesives must be used in the construction of the doorsets. These may be hand applied or may be applied using an edgebander. With either method it must be ensured that sufficient glue is applied across the entire surface area between the 2No substrates being adhered to guarantee a robust bond. Other manufacturers guidance should be followed, for either installation application used.

Element	Product/Material Type
Timber lipping	Urea formaldehyde, Resorcinol formaldehyde, Polyurethane
T-shaped Lippings	KoyoBond KR-560 + AP crosslinker
Decorative facings	UF, PUR or hotmelt EVA or PUR

### Note:

1. Flamebreak door leaves are proprietary products under the control of Pacific Rim Wood Ltd and manufactured by P.T. Kutai Timber of Indonesia. The adhesives for constructing the door blank are held in confidence (WF503863). The adhesives listed above are necessary for further fabrication of the door blanks into doorsets.

## 10 Hardware

### 10.1 General

The following section details the permitted scope and constraints for fitting hardware to this door design. The following items of hardware must also bear the UKCA or CE Mark in addition to the requirements outlined in the following sections. The UKCA or CE mark must indicate that the hardware is suitable for fire doors in the classification code and declaration of performance issued by the hardware manufacturer:

- Latches & locks: Test Standard EN 12209
- Single axis hinges: Test Standard EN 1935
- Controlled door closing devices: Test Standard EN 1154
- Electrically powered hold-open devices: Test Standard EN 1155
- Door co-ordinators: Test Standard EN 1158
- Emergency exit hardware: Test Standard EN 179
- Panic exit hardware: Test Standard EN 1125.

The following sections consider what tested and assessed alternative items of essential and non-essential hardware can be used on the doorset range.

Items of hardware have been considered and approved via the following means:

- The component has been successfully tested to BS 476 Part 22: 1987 or BS EN 1634-1 in a suitably similar type of doorset e.g. timber leaf in timber frame.
- As a result of an assessment of the appropriateness of the item of hardware, based on test evidence not commissioned by Pacific Rim Wood Ltd.
- As a result of the Certifire approval of the item of hardware

Each section will consider the named item of hardware and detail if there are any limitations associated with:

- Leaf size
- Configuration
- Intumescent seals
- Intumescent protection
- Frame configuration requirements.

No item of hardware should be within 200mm of another item of hardware unless there is test evidence to demonstrate they can be in closer proximity.

Hardware items should generally be fitted in accordance with the manufacturer’s instructions. **However, the parameters and requirements of this assessment always take precedence, including specified protection such as hardware gaskets.** Referenced Certifire approved hardware may be incorporated subject to the design, material and dimensional limitations identified within this assessment report and identified on the relevant Certifire certificate.

## 10.2 Intumescent to Hardware

The intumescent materials used to protect hardware that have been tested and assessed for this doorset design are detailed below. Note that any one of the product/manufacturer options listed in the table may be used in the specific application noted. However, only 1No manufacturer should be considered per doorset application.

The door gap perimeter intumescent seal specifications are documented in conjunction with the leaf envelope size limitations in section 4.5.

Item	Location	Product/Manufacturer
Hinges	Under both blades (only required for leaves over 2400mm high)	1. 1mm Interdens – Dufaylite Developments Ltd. 2. 1mm MAP paper – Lorient Polyproducts Ltd. 3. 1mm Pyrostrip 300 – Mann McGowan Ltd.
Lock/latches	Under forend & keep for double doorsets or if the forend or keep > 150mm (h) up to the maximum assessed dimension	4. 1mm Therm-A-Strip – Intumescent Seals Ltd. 5. 1mm G30 – Sealmaster Ltd. 6. 1mm NOR910 – Norsound Ltd. 7. 1mm Graphite gasket - Sealed Tight Solutions
Concealed overhead closer	Fitted to top of body in the door leaf and sides of the slide arm in frame head	Rutland IP.114 pre-cut self-adhesive (t) graphite based gaskets
Top pivots & bottom straps	Lining all sides of the mortices	1. 2mm MAP paper – Lorient Polyproducts Ltd. 2. 2mm Interdens – Dufaylite Developments Ltd. 3. 2mm G30 – Sealmaster Ltd.
Flush bolts	Lining all sides of the mortices	4. 2mm Therm-A-Strip – Intumescent Seals Ltd. 5. 2mm Therm-A-Flex – Intumescent Seals Ltd. 6. 2mm NOR920 – Norsound Ltd. 7. 1mm Graphite gasket - Sealed Tight Solutions

Gaskets must be fitted where required by supporting evidence, for example, test evidence or Certifire certificates. If gaskets are not required by the supporting evidence but are within this Field of Application, the requirements of this Field of Application take precedence.

Where it is stated that intumescent is not required for a particular element of hardware, it is permitted to use up to 2mm thick MAP, Interdens or graphite-based gasket tested for the particular application [as appropriate for the hardware]. It is the opinion of Warringtonfire that the additional protection will not detract from the fire resistance performance under test conditions.



### 10.3 Essential Hardware

The following table details the essential hardware for the various doorset configurations that are referenced in this assessment.

Configuration	Hardware
LSASD	<ul style="list-style-type: none"> <li>• Latch</li> <li>• Handle</li> <li>• Hinges</li> <li>• Self-closing device (closer)</li> </ul>
ULSASD	<ul style="list-style-type: none"> <li>• Hinges</li> <li>• Self-closing device (closer)</li> </ul>
DASD	<ul style="list-style-type: none"> <li>• Top pivot &amp; bottom strap</li> <li>• Self-closing device (closer)</li> </ul>
LSASD+OP	<ul style="list-style-type: none"> <li>• Latch</li> <li>• Handle</li> <li>• Hinges</li> <li>• Self-closing device (closer)</li> </ul>
ULSASD+OP	<ul style="list-style-type: none"> <li>• Hinges</li> <li>• Self-closing device (closer)</li> </ul>
DASD + OP	<ul style="list-style-type: none"> <li>• Top pivot &amp; bottom strap</li> <li>• Floor spring</li> </ul>
LSADD	<ul style="list-style-type: none"> <li>• Latch</li> <li>• Handle</li> <li>• Hinges</li> <li>• Self-closing device (closer)</li> <li>• Flush bolt</li> </ul>
ULSADD	<ul style="list-style-type: none"> <li>• Hinges</li> <li>• Self-closing device (closer)</li> <li>• Flush bolt (if specified)</li> </ul>
DADD	<ul style="list-style-type: none"> <li>• Top pivot &amp; bottom strap</li> <li>• Self-closing device (closer)</li> </ul>
LSADD+OP	<ul style="list-style-type: none"> <li>• Latch</li> <li>• Handle</li> <li>• Hinges</li> <li>• Self-closing device (closer)</li> <li>• Flush bolt</li> </ul>
ULSADD+OP	<ul style="list-style-type: none"> <li>• Hinges</li> <li>• Self-closing device (closer)</li> </ul>
DADD + OP	<ul style="list-style-type: none"> <li>• Top pivot &amp; bottom strap</li> <li>• Self-closing device (closer)</li> </ul>

Where astragals and/or rebated edges are specified, a door selector to the requirements of section 10.9.4 must be fitted.

## 10.4 Latches & Locks

Unless explicitly detailed within the sections below only 1No. lock or latch shall be applied within any individual doorset. When fitted the lock or latch body shall be installed within the vertical edge of the door leaf in all cases, at a height as detailed within the relevant section below. Refer to specific notes contained within each section for further considerations on lock or latch type.

### 10.4.1 Single Point Engagement

These items are suitable in the following applications only:

**Leaf options:** Type 1 - 6

**Frame options:** 1 and 2

**Configurations:** All permitted in section 4.5.2

The table below details the tested latches and locks that are approved.

Element	Manufacturer & Product Reference
Locks & latches	1. Henderson Hardware tubular mortice latch 2. E*S Hardware tubular mortice latch 3. Nemeff latch 4. Sparka lever operated mortice latch

Alternatively, components with the following specification are also deemed acceptable.

#### Single & Double leaf doorsets

Element	Specification
Maximum forend and strike plate dimensions	235mm high x 25mm wide x 4mm thick
Maximum body dimensions	165mm high x 100mm wide x 18mm thick
Intumescent protection	see section 10.2
Materials	All parts essential to the locking/latching action (including the latch bolt, forend and strike) to be steel, stainless steel or brass with a melting point $\geq 800^{\circ}$ C

#### Notes:

1. In all instances the location of the handle must be between 750 – 1200mm from the threshold.

### 10.4.1.1 Assa Abloy 351M.80

The Assa Abloy 351M.80 has been approved for use on the proposed door designs based on the following:

Test reference: WF434693/LR Issue 2 (Doorsets A & B):

Test WF434693/LR Issue 2 successfully included the following hardware for both 30 and 60 minute duration on a 44 and 54mm thick timber based door leaf, tested on a single acting, single leaf doorset:

- Assa Abloy 351U.80 fitted in the frame jambs
- Assa Abloy 352M.80 fitted in the frame head.

The construction and body dimensions of both locks are the same as the proposed 351M.80, and the strike of the 352M.80 is the same as shown below:

This test successfully included the Assa Abloy 351U.80 and Assa Abloy 352M.80 electric strike release with a case dimension of 139 x 39 x 32mm deep in the frame head of a doorset comprising a 54mm thick timber based construction, tested on a single acting, single leaf doorset.

This test provides evidence:

- That a solid timber based door blank is capable of accommodating the Assa Abloy 351U.80 and Assa Abloy 352M.80.
- That the Assa Abloy 351U.80 and Assa Abloy 352M.80 locks are capable of tolerating fire exposure for 30 and 60 minutes without undermining the fire integrity of the doorset.

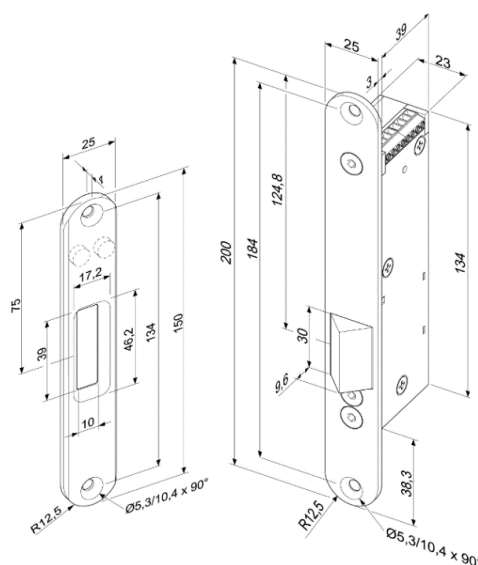

Based on the similarities in the design and dimensions of the tested Assa Abloy 352M.80 to the proposed Assa Abloy 351M.80 it is the opinion of Warringtonfire that if the Assa Abloy 351M.80 were to be tested, the performance achieved would be comparable to that of the Assa Abloy 352M.80.

The fitting of the Assa Abloy 351M.80 requires an increase in the frame (type 1 only) head or jamb thickness (depending on the placement of the lockset body) to a minimum of 45mm.

### 10.4.1.2 Hardware protection for Assa Abloy 351M.80

The following protection is required for the Assa Abloy 351M.80 locks.

Intumescent type:

- Interdens

Size and location:

- 2mm thick, fitted underneath strike.
- 1mm wrapped around the lockcase body.

## 10.4.2 Latches & Locks – Multi Point Engagement

These items are suitable in the following applications only:

**Leaf options:** 1 only

**Frame option:** 1 only

**Configurations:** LSASD

The table below details the tested multi point latch that is approved.

Element	Manufacturer & Product Reference
Locks & latches	1. Winkhaus 3 pt lock ref: AV-2

### 10.4.2.1 When Installed using Intumescent specification X1

The tested Winkhaus 3 pt Autofire multipoint lock may be utilised with the leaf type 1 only, stiles and bottom rail may be removed as tested in 18-003111-PR04, intumescent seals as detailed in section 4.5.5.21 must be installed, the head rail must remain in place to the full dimensions shown in section 5.1, the locks must be installed with the tested intumescent protection detailed below. The auto-firing hooks and latch bolt must be engaged when not in active use.

Element	Specification (mm)
Forend	1770 high by 20 wide
Centre Lock Keep	234 high x 24 wide
Top & Bottom Keeps	174 high x 24 wide
Top & Bottom Lock Bodies	113mm high by 42mm wide by 16mm thick
Lock Cylinder	A lock cylinder must always be installed
Intumescent protection	Encasing all lock bodies, and top and bottom hook bodies – 1mm thick STS graphite gasket Under all lock keeps – 1mm thick STS graphite gasket Under Forend – Not required
Materials	All parts essential to the lock must remain as tested
Location	Centre lock nib to be installed between 950mm and 1100mm from the threshold
Leaf Edge Seals	ST154FO- Sealed Tight Solutions Ltd - Intumescent specification X1
Maximum Leaf Size (mm)	See section 4.5.5.21
Configurations	Latched, single acting, single leaf only

Based on the results of WF393276B the Winkhaus Trulock Pyro 3pt latch may also be used. This product does not auto engage at all 3 locking points. The Flamebreak design has been successfully tested with multi point latches, as discussed in section 10.4.2, and the AV2 which has identical case sizes and forend dimensions to the Trulock Pro. It is therefore our assessment that installation of the Trulock Pyro would not be expected to be the cause of premature integrity failure.

### 10.4.2.2 When Installed using Intumescent specification XA1

The tested Winkhaus 3 pt Autofire multipoint lock may be utilised with the leaf type 1 only, stiles and bottom rail may not be removed, intumescent seals must be as detailed in section 4.5.5.21 referenced as XA1, the head rail must remain in place to the full dimensions shown in section 5.1, the locks must be installed with the tested intumescent protection detailed below. The auto-firing hooks and latch bolt must be engaged when not in active use.

Element	Specification (mm)
Forend	1770 high by 20 wide
Centre Lock Keep	234 high x 24 wide
Top & Bottom Keeps	174 high x 24 wide
Top & Bottom Lock Bodies	113mm high by 42mm wide by 16mm thick
Lock Cylinder	A lock cylinder must always be installed
Intumescent protection	Encasing all lock bodies, and top and bottom hook bodies – 1mm thick Interdens gasket Under all lock keeps – 1mm thick Interdens gasket Under Forend – Not required
Materials	All parts essential to the lock must remain as tested
Location	Centre lock nib to be installed between 950mm and 1100mm from the threshold
Leaf Edge Seals	Lorien Polyproducts Type 617 - Intumescent specification X1
Maximum Leaf Size (mm)	See section 4.5.5.21
Configurations	Latched, single acting, single leaf only

Based on the results of WF393276B the Winkhaus Trulock Pyro 3pt latch may also be used. This product does not auto engage at all 3 locking points. The Flamebreak design has been successfully tested with multi point latches, as discussed in section 10.4.2, and the AV2 which has identical case sizes and forend dimensions to the Trulock Pro. It is therefore our assessment that installation of the Trulock Pyro would not be expected to be the cause of premature integrity failure.

### 10.4.3 Cylinders

These items are suitable in the following applications only:

**Leaf options:** Types 1 - 6

**Frame options:** 1 and 2

**Configurations:** LSASD, LSASD+OP, LSADD, LSADD+OP

The table below details the tested cylinders that are approved.

Element	Manufacturer & Product Reference
Cylinder	<ul style="list-style-type: none"><li>• ERA BS-L-T-T3535-51</li><li>• Sparka LL1313.MAS</li><li>• Ultion ref: DCBSW3535DT-R177</li></ul>

Alternatively, components with the following specification are also deemed acceptable.

- Where required for use with either single or multi point latches, the cylinder must be constructed of either brass or steel with a melting point in excess of 800°C.
- The cylinder must be compatible with the lock/latch.
- Cylinder dimensions may be up to 33mm high x 17.5mm wide at the maximum dimension and may be of euro profile or oval.
- Single and double cylinders, along with cylinder & turn are permitted.
- Door preparation for single cylinders shall penetrate only half the door thickness.
- Intumescent protection and tightness of fitting:
  - If the lock body is not protected with an intumescent material, the maximum clearance between leaf and cylinder is 1mm to each edge.
  - If the lock body is protected with an intumescent material, maximum clearance between leaf and cylinder is 3mm to each edge.
  - 1mm thick MAP or non-pressure forming graphite intumescent around the cylinder is optionally permitted.

## 10.5 Handles & Escutcheons

These items are suitable in the following applications only:

**Leaf options:** Types 1 - 6

**Frame options:** 1 and 2

**Configurations:** - LSASD, LSASD+OP, LSADD, LSADD+OP

The table below details the tested handles that are approved.

Element	Manufacturer & Product Reference
Handles	<ul style="list-style-type: none"><li>Aluminium lever type handle</li><li>Stainless steel lever type handle</li></ul>

Alternative handles are permitted providing they meet the specification given below:

- Steel, stainless steel, brass, aluminium or bronze are permitted.
- Surface fixings or through fixings are permitted. If through fixed there must be no more than 0.5mm clearance between the hole and the fixing.
- The hole through the leaf to facilitate the spindle must be no greater than 20mm diameter.

The design may be either handle on rose or handle on back plate up to the following maximum sizes:

- Handle on rose with a rose diameter up to 54mm.
- Handle on back plate with a back plate size up to 243mm high x 56mm wide.
- Lever handle length 250mm.

The handle must be compatible with the lock/latch, such that the closing action of the doorset is not impeded.

Alternative escutcheons are permitted providing they meet the specification given below:

- Steel, stainless steel, brass, aluminium or bronze are permitted.
- Surface fixings or through fixings are permitted. If through fixed there must be no more than 0.5mm clearance between the hole and the fixing.
- The escutcheon may be up to Ø52mm overall and up to 8mm thick.

## 10.6 Butt Hinges

These items are suitable in the following applications only:

**Leaf options:** 1 to 6

**Frame options:** 1 and 2

**Configurations:** LSASD, ULSASD, LSASD+OP, ULSASD+OP, LSADD, ULSADD, LSADD+OP, ULSADD+OP

The table below details the tested butt hinges that are approved.

Element	Manufacturer & Product Reference
Hinges	<ul style="list-style-type: none"> <li>Royde &amp; Tucker H105 steel butt type hinges</li> <li>Stainless steel butt type hinges</li> <li>Jedo steel bearing butt hinges ref: 102</li> <li>Sparka steel bearing butt hinges ref: HG1010.SSS</li> </ul>

Alternatively, components with the following specification are also deemed acceptable.

Element	Specification
Blade height:	90 - 120mm
Blade width (excluding knuckle):	30 - 35mm
Blade thickness	2.5 - 4mm
Fixings:	Minimum of 4 No. 30mm long No. 8 or No.10 steel wood screws per blade
Materials:	Steel or stainless steel or brass (melting point $\geq 800^{\circ}\text{C}$ )

### Notes:

- It is also permitted to use screw fixings as tested and supplied with the hinges approved for the Pacific Rim Wood Ltd. Flamebreak 30 design at 30 minutes fire resistance.
- Flamebreak 30 leaves must be hung on:
  - A minimum of 2 hinges for leaves below 1500mm high with hinges at top and bottom positions shown in table above
  - A minimum of 3 hinges for leaves below 2400mm high
  - A minimum of 4 hinges for leaves below 3000mm high
  - A minimum of 5 hinges for leaves above 3000mm high.



In all instances, the hinges must have the following specification.

Element		Specification	
Hinge positions:	3No hinges required: Leaf dimensions <2400mm	Top	120 -180mm from the head of the leaf to the top of the hinge
		2 <sup>nd</sup>	Minimum 100mm from bottom of top hinge to top of second to centrally between top and bottom hinges
		Bottom	150 - 250mm from the foot of the leaf to the bottom of the hinge
	4No hinges required: Leaf dimensions ≥2400mm	Top	120 - 180mm from the head of the leaf to the top of the hinge
		2 <sup>nd</sup> and 3 <sup>rd</sup>	Equispaced between top and bottom or 2 <sup>nd</sup> hinge a minimum 200mm from bottom of top hinge to top of second and 3 <sup>rd</sup> hinge equally spaced between 2 <sup>nd</sup> and bottom hinge
		Bottom	150 - 250mm from the foot of the leaf to the bottom of the hinge
Intumescent protection:		See section 10.2	

### 10.6.1 Safehinge™ ALUmax

The Safehinge ALUmax system is assessed within Chilt/A12005 Revision G for use in a range of timber based doorset construction types for both 30 and 60 minutes integrity performance. Chilt/A12005 Revision G details door frame, intumescent seal and installation requirements for use of the ALUmax system, which must be complied with in full where the ALUmax system is proposed for use with the Pacific Rim Wood Ltd. Flamebreak 30 design for 30 minutes fire resistance. Where specific details in Chilt/A12005 Revision G are different to those herein, whichever is the superior specification must be utilised.

Permitted configurations are limited to LSASD, ULSASD, DASD, LSADD, ULSADD and DADD, at the maximum leaf sizes shown in sections 4.5.5.1 to 4.5.5.4.

The use of Safehinge concealed overhead closers is not permitted.

### 10.7 Doorset Self Closing

Doorset automatic self-closing can be provided by:

- Overhead face fixed closers.
- Concealed overhead closers.
- Floor springs with top pivots and bottom straps.

Automatic doorset self-closing devices such as transom mounted, and offset pivots used with floor springs are not considered acceptable for use with the Flamebreak doorset range.

## 10.7.1 Overhead Face Fixed Closer

**Leaf options:** Types 1 - 6

**Frame options:** 1 and 2

**Configurations:** All in section 4.5.2

The table below details the tested overhead face-fixed closers that are approved.

Element	Manufacturer & Product Reference
Overhead face-fixed closers	<ul style="list-style-type: none"> <li>Dorma TS71; TS73V; TS83V overhead type door closers</li> <li>Arrone AR1500</li> <li>Surface mounted Synergy s800 EN2-5</li> <li>Surface mounted Eclipse 28730</li> <li>Rutland UK TS5204; TS9205; TS11205 overhead type door closers</li> </ul>

Alternatively, components with the following specification are also deemed acceptable.

- Certifire approved overhead face-fixed closers for 30-minute fire resistance applications on 44mm thick timber door and timber frames.

### Note:

It must be ensured that the closer is of sufficient strength and power to ensure the door leaf/leaves fully engage into the frame reveal.

## 10.7.2 Concealed Overhead Self Closing Device

These items are suitable in the following applications only, subject to the details in the table below:

**Leaf options:** Leaf types 1, 2 and 5 and type 4 with maximum 6mm thick facings

**Frame options:** 1 only

**Configurations:** LSASD, ULSASD, LSADD, ULSADD.

The table below details the tested concealed overhead closers that are approved with the body of the concealed closer morticed into the top of the door leaf and the track morticed into the frame head.

Maximum leaf size for all configurations is 2351mm high x 1066mm wide, which takes precedence over the dimensions in the data sheets in section 4.5.

Manufacturer & Product Reference (Test Reference)	Intumescent Protection	Closer Body Dimensions	Closer Slide Arm Dimensions	Minimum Head Stop Height (mm)
Rutland UK ITS11204 (WF522957)	Rutland IP114 gasket set	243(l) x 57(d) x 32(w)	460(l) x 19(d) x 31(W)	12 for LSASD, ULSASD, LSADD, ULSADD

### Notes:

Based on the test evidence the above tested and assessed concealed closers are permitted for use with the doorset design subject to the following parameters:

- Minimum frame head dimensions (additional to section 7):
  - Frame 1: 34mm thick.

- The details identified in the table above for the following items must be followed for the selected concealed overhead closer, and is based on the tested arrangements:
  - Frame option(s).
  - Permitted configuration(s).
  - The frame must be fitted with a head stop of the minimum size, where required.
  - Intumescent protection to the concealed closer.
  - Leaf perimeter intumescent details.
- It must be ensured that the concealed overhead closer is of sufficient strength and power to ensure the door leaf/leaves fully engage into the frame reveal.
- The dimensions of the concealed overhead door closer must not exceed the dimensions given within the tables above.
- Double acting operation of concealed closers has not been proven by test and is therefore not permitted.
- The use of shadow gap installations is not permitted in conjunction with concealed overhead closers.

### 10.7.3 Floor Spring Self Closing Device

These items are suitable in the following applications only:

**Leaf options:** Leaf types 1 and type 4 with maximum 4mm thick facings

**Frame options:** 1 only

**Configurations:** DASD & DADD

Components with the following specification are deemed acceptable.

- Certifire approved floor spring self-closers for 30-minute fire resistance applications on 44mm thick timber door and timber frames.

**Note:** For intumescent protection requirements, see section 10.2.

#### 10.7.3.1 Hardwood Blocking for Floor Spring Self Closing Devices

The following option is required for lipping the bottom of doors that are to receive pivot fixings and are to be used in severe duty locations (diagram below). It is not necessary to introduce additional blocking at the head of the door because of the presence of the integral top rail.

The hardwood insert may be a maximum of 15mm high by a length suitable for the hardware to be installed plus a maximum of 50mm (not full door width). The hardwood insert must be a maximum of 28mm wide and fitted centrally in the leaf leaving 8mm of leaf material on either face. The inserted block must be bonded on all contact faces using adhesives approved for the application of lippings (see section 9). Alternatively, lippings in accordance with details shown in section 5.2.3 may be used.

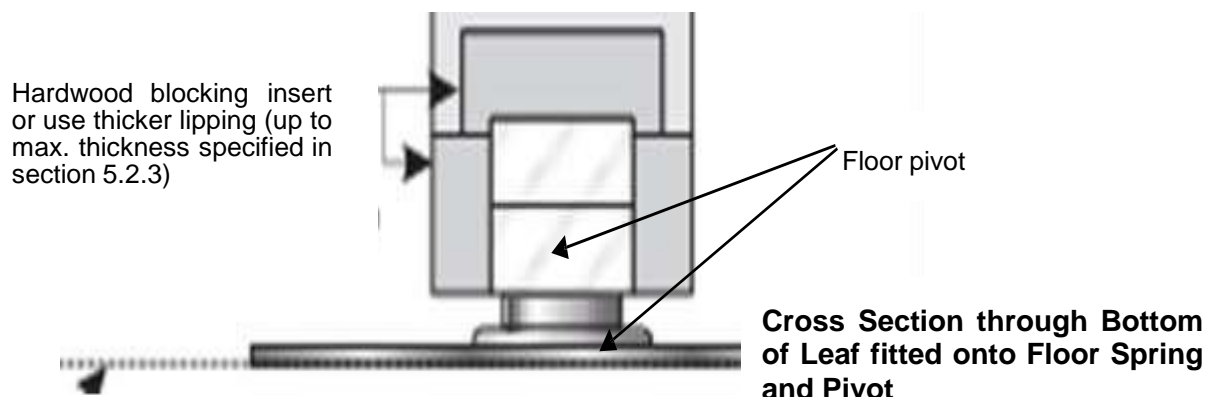

## 10.8 Bolts

### 10.8.1 Flush Bolts

These items are suitable in the following applications only:

**Leaf options:** 1 to 6

**Frame options:** 1 and 2

**Configurations:** LSADD (OPTIONALLY ULSADD)

Flush bolts may be incorporated centrally into the top and bottom of one meeting edge, providing the following maximum dimensions are not exceeded and the components are fitted opposite the edge fitted with intumescent strips:

- 210mm long x 20mm deep x 20mm wide.

Flush bolts must be steel, and the mortice must be as tight to the mechanism as is compatible with its operation. All edges of the mortice of the keep and body must be protected with intumescent gaskets as specified in section 10.2. Alternatively, the hardware manufacturers tested gaskets may be used.

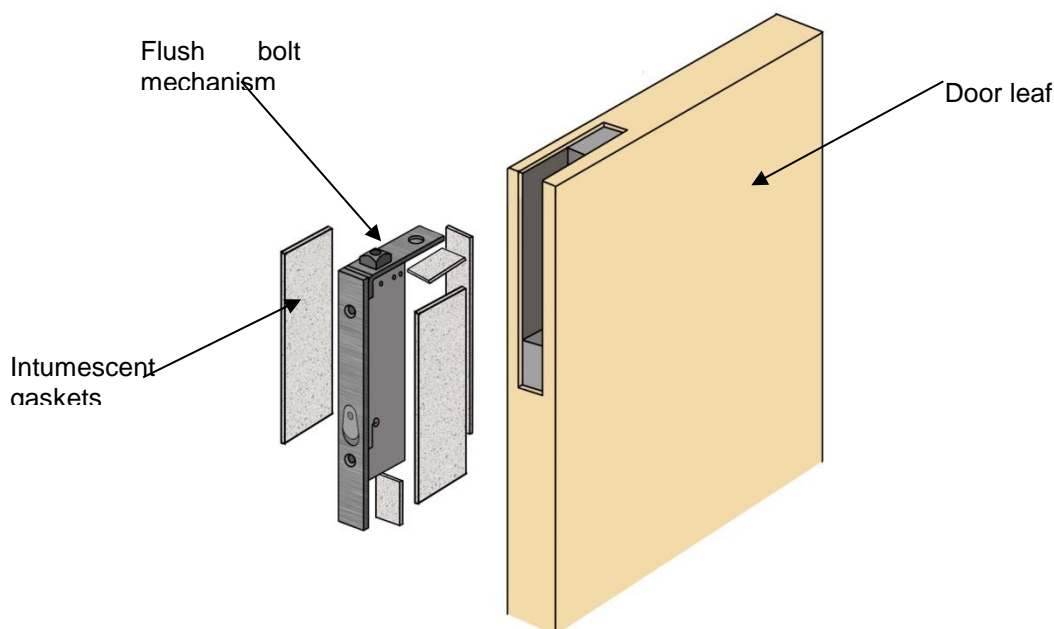

### 10.8.2 Surface Mounted Face Fixed Bolts

These items are suitable in the following applications only:

**Leaf options:** 1 to 6

**Frame options:** 1 and 2

**Configurations:** LSADD (OPTIONALLY ULSADD)

Surface mounted face fixed bolts constructed from steel, stainless steel, aluminium or bronze may be fitted to the top and bottom of one leaf within a double doorset design, providing the following maximum dimensions given below are not exceeded and the components are fitted at least 50mm from the meeting edge:

- 300mm long x 20mm wide (footprint).

Intumescent protection is not required.

## 10.9 Non-Essential Hardware

Only the following items of non-essential hardware are permitted in addition to the prescribed essential hardware as detailed within sections 10.3 – 10.8.

### 10.9.1 Pull Handles

These items are suitable in the following applications only:

**Leaf options:** Types 1 - 6

**Frame options:** 1 and 2

**Configurations:** All in section 4.5.2.

Steel, stainless steel or bronze handles may be surface-fixed or bolted through the door leaf, providing the length is limited to 1200mm between the fixing points. If through fixed, there must be no more than 1mm clearance between the hole and stud.

The above scope of application is provided as in the opinion of Warringtonfire they will not significantly affect the fire resistance performance of the doorset being considered. This is on the basis of the items being surface mounted away from the edge of the door leaf, therefore unlikely to influence the junction between door leaf and frame. Furthermore, they are generally of lightweight construction, meaning that they are unlikely to destabilise the doorset and therefore cause adverse deflection under test conditions. Lastly, the surface mounted arrangement of the features means no material is removed in terms of the overall thickness of the door leaf beyond the footprint of the item, therefore burn through of the leaf would not be expected.

### 10.9.2 Push Plates & Kick Plates

**Leaf options:** Types 1 - 6

**Frame options:** 1 and 2

**Configurations:** All in section 4.5.2.

Components with the following specification are deemed acceptable as in the opinion of Warringtonfire they will not significantly affect the fire resistance performance of the doorset being considered. This is on the basis of the items being surface mounted away from the edge of the door leaf, therefore unlikely to influence the junction between door leaf and frame. Furthermore, they are generally of lightweight construction, meaning that they are unlikely to destabilise the doorset and therefore cause adverse deflection under test conditions. Lastly, the surface mounted arrangement of the features means no material is removed in terms of the overall thickness of the door leaf beyond the footprint of the item, therefore burn through of the leaf would not be expected.

Approved specification:

- Polymeric or metal face-fixed hardware such as push plates and kick plates up to 2mm thick may be surface fitted to the doorset. These items of hardware are permitted up to a maximum of 20% of the door leaf area if mechanically fixed and a maximum of 30% if bonded with a contact or other thermally softening adhesive.
- Plates must not return around the door edges.
- In all cases plates meeting the above specification shall not be applied under glazing beads or door stops.

### 10.9.3 Security Viewers

These items are suitable in the following applications only:

**Leaf options:** Types 1 - 6

**Frame options:** 1 and 2

**Configurations:** All in section 4.5.2.

Up to 2no. viewers are permitted within a single door leaf, viewers are to be positioned no closer together than 100mm, no closer than 100mm to door edges, glazed apertures or any other hardware component.

The table below details the tested security viewers that are approved, in all cases the tested viewers shall include the intumescent specification which has been proven within the doorset design.

Element	Manufacturer & Product Reference	Intumescent Protection
Security Viewer	Sparka ref: BA1013.SCP (2No tested)	1mm thick intumescent sleeve provided by Sparka
	UAP ref: SWALF	1mm thick intumescent sleeve provided by UAP

Alternatively, components with the following specification are also deemed acceptable.

- Door security viewers with brass or steel bodies of a diameter less than or equal to 15mm may be used provided that the through-hole is bored tight to the case of the viewer (maximum tolerance +1 mm). Lenses must be glass and the item must be protected with a tested acrylic intumescent mastic and / or a 0.5 – 1.0mm thick graphite based intumescent wrap.

### 10.9.4 Door Selectors

These items are suitable in the following applications only:

**Leaf options:** Types 1 - 6

**Frame options:** 1 and 2

**Configurations:** All in section 4.5.2.

These may be freely applied, provided that they are not invasive in the leaf edges or door frames, and they do not interfere with the self-closing action of the door leaf. Products that are invasive will require fire resistance test/assessment evidence to support their use.

### 10.9.5 Air Transfer Grilles

These items are suitable in the following applications only:

**Leaf options:** Leaf types 1 and type 4 with maximum 4mm thick facings

**Frame options:** 1 and 2

**Configurations:** All configurations

Based on the test evidence generated in WF146520 the following Pyroplex air transfer grilles have been assessed as acceptable for use with the Flamebreak 30 door leaf types herein.

The grilles must be fitted 110mm from the edge of the door leaf and 80mm apart if more than one grille is to be fitted. The area occupied by the air transfer grille(s) must be deducted from the area of glazing if both elements are fitted. The grilles may be fitted up to a maximum height of 2200mm from the threshold.

Part No.	Dimensions (mm)	Air Flow (sq. cm)	Compatible Faceplates
ATG 1500	150 x 150	153	FP1500
ATG 1503	150 x 300	307	FP1503
ATG 1300	300 x 300	614	FP1300
ATG 2251	112 x 225	161	FP2251
ATG 2250	225 x 225	323	FP2250

Pyroplex air transfer grilles must be installed in accordance with the manufacturer's installation details, which include a 6mm thick hardwood aperture liner and Pyroplex intumescent mastic applied around the perimeter of the grille. Full details can be obtained from Pyroplex Ltd.

### 10.9.6 Environmental Seals

**Leaf options:** Types 1 - 6

**Frame options:** 1 and 2

**Configurations:** All configurations

A number of different environmental seals have been successfully tested as part of the Flamebreak doorset leaf types. For example, the Norseal Ltd 710 single flipper weather seal was successfully tested in report RF10128.

On this basis, silicon based flame retardant acoustic, weather and dust seals e.g. Lorient LAS1007, LAS1206, LAS1206K, LAS1010, LAS1212, LAS1212K, LAS1215, IS1511, IS7025, IS7060, Norseal NOR710, NOR720, NOR510; Fire & Acoustic Seals Ltd. FAS35, FAS39, FAS Trident, FAStragal or Sealed Tight Solutions ST1009) may be fitted to this doorset design without compromising the performance, providing their fitting does not interfere with the activation of the intumescent seals or hinder the self-closing function of the leaves.

Where required, the seals may be fitted either rebated into the timber door stop or rebated into the leaf face.

### 10.9.7 Threshold drop Seals

These items are suitable in the following applications only:

**Leaf options:** Types 1 - 6

**Frame options:** 1 and 2

**Configurations:** All configurations

A NOR810S drop down seal was successfully tested in report RF10128 and a Sparka TU1218 was successfully tested in WF522957 and are therefore acceptable for use in all door designs. It is permitted for use without the requirement for any intumescent protection.

**Note**, if a rebated drop seal is fitted to the doorset then flush bolts, if approved, may not be fitted to the bottom of the doorset.

Alternatively, components with the following specification are also deemed acceptable, recessed into the bottom of leaves.

Product	Manufacturer
LAS8001si, LAS8005si	Lorient Polyproducts Ltd.
IS8010si	Lorient Polyproducts Ltd.
RP8Si	Raven Products Ltd.
NOR810, NOR810S, NOR810dB+	Norsound Ltd.
Schall-Ex Duo L-15	Athmer
STS 422 & STS422GT	Sealed Tight Solutions Ltd
FAS45 & FAS810S	Fire & Acoustic Seals

### 10.9.8 Letter Boxes / Plates

These items are suitable in the following applications only:

**Leaf options:** Types 1 - 6

**Frame options:** 1 and 2

**Configurations:** All configurations.

Letterplates are permitted however the following requirements must be observed:

- The area of the letter plate (and air transfer grille if present) plus any glazing must not exceed the total permitted area for glazing in the leaf.
- The letterplate shall be installed at a location of 500mm to 1000mm from the bottom of the leaf and shall be no closer than 250mm to the edge of the leaf or 100mm from any other apertures within the leaf.

The table below details the tested letter plates that are approved.

Element	Manufacturer & Product Reference
Letter plate	<ul style="list-style-type: none"> <li>• Sparka ref: LE1013.SCP</li> </ul>

Alternatively, components with the following specification are also deemed acceptable.

- Letter boxes/plates must be Certifire approved for 30 minutes in doorsets with solid timber door leaves. Restriction relating to size, location and intumescent protection around the letter box/plate must be complied with.



### 10.9.9 Security Chains

Components with the following specification are deemed acceptable as in the opinion of Warringtonfire they will not significantly affect the fire resistance performance of the doorset being considered. This is on the basis of the items being surface mounted with fixings positioned away from the edge of the door leaf and therefore unlikely to influence the junction between door leaf and frame. Furthermore, they are generally of lightweight construction, meaning that they are unlikely to destabilise the doorset and cause adverse deflection under test conditions. Lastly, the surface mounted arrangement of the features means no material is removed in terms of the overall thickness of the door leaf beyond the footprint of the item, therefore burn through of the leaf would not be expected.

Approved specification:

- Metallic security chains may be surface fixed to the face of the door leaf and frame, providing they are fitted such that they do not interfere with the junction between the leaf edge and the frame, and no material is removed in order to facilitate the fitting of the security chain. Screws to affix the security chain shall be no greater than 25mm long.

### 10.9.10 Knockers, Numerals & Signage

Components with the following specification are deemed acceptable as in the opinion of Warringtonfire they will not significantly affect the fire resistance performance of the doorset being considered. This is on the basis of the items being surface mounted away from the edge of the door leaf, therefore unlikely to influence the junction between door leaf and frame. Furthermore, they are generally of lightweight construction, meaning that they are unlikely to destabilise the doorset and therefore cause adverse deflection under test conditions. Lastly, the surface mounted arrangement of the features means no material is removed in terms of the overall thickness of the door leaf beyond the footprint of the item, therefore burn through of the leaf would not be expected.

Approved specifications:

Knockers:

- Steel, stainless steel, aluminium or bronze knockers, may be surface fixed or bolted through the door leaf, providing they are fitted no closer than 75mm from the leaf edge, other elements of building hardware or to any glazing and are no greater than 200mm high x 120mm wide. If through fixed, there must be no more than 1mm clearance between the hole and stud. It is only permitted to fit 1No. knocker to any one doorset.

Numerals & Signage:

- Steel, stainless steel, aluminium or bronze numerals or signage may be surface fixed to the door leaf, providing they are fitted no closer than 35mm from the leaf edge, other elements of building hardware or to any glazing. The dimension of each numeral or sign must be no greater than 200mm high x 100mm wide x 4mm thick. Up to 5No. numerals or signs may be applied to a doorset, numerals and signs may be applied adjacent to each other providing the 35mm from other elements as detailed above is maintained.

### 10.9.11 Panic Hardware

These items are suitable in the following applications only:

**Leaf options:** Types 1 - 6

**Frame options:** 1 only

**Configurations:** All configurations

Certifire approved panic hardware may be fitted, providing the installation does not require the removal of any timber from the leaf, stop or frame reveal and it does not interfere with the self-closing action of the door leaf.

The fitting of panic hardware is not considered to change the latching arrangement of the doorset and therefore the permitted leaf size shall be established using unlatched doorset configurations as detailed within section 4.5.2.

### 10.9.12 Fire Door Identification Plates

Plastic or metal fire door identification plates may be glued or screwed to the face of the door leaves providing they are fitted no closer than 35mm from the leaf edge, other elements of building hardware or to any glazing. The dimension of any applied plate must be no greater than 100mm high x 100mm wide x 3mm thick.

These may be required to identify the following:

- a) To be kept closed when not in use (Fire Door Keep Shut)
- b) To be kept locked shut when not in use (Fire Door Keep Locked Shut)
- c) Held open by an automatic release mechanism or free swing device (Automatic Fire Door Keep Clear).

When applied to a door leaf the plate shall be surface mounted to the face without removing material from the leaf.

### 10.9.13 Fire Door Data Tags

The table below details the tested NFC tags that are approved.

Element	Manufacturer & Product Reference
Tags	1. BM TRADA – ‘Q-Mark plug’ 2. Door Data Systems – Data tag.

The following limitations must be adhered to when fitting a smart tag to the doorset:

#### Edge Mounted (Door leaf edge)

- The smart tag must be fitted into a tight rebate such that the smart tag finishes flush with the lipping material.
- The smart tags shall be applied within the hanging edge of the door leaf only.
- The smart tag shall be positioned centrally within the thickness of the door leaf.
- The smart tag shall be fitted no closer than 100mm below the top hinge position, measured from the centre of the tracker tag.
- The smart tag must be no closer than 100mm to any other element of hardware.
- It is not permitted to interrupt or remove intumescent material within the doorset to apply the above detailed tags.
- The smart tags shall not be applied over intumescent materials within the leaf edge but may be fitted opposing them.

## 11 Installation



### 11.1 General

This section considers the installation of doorsets. This section considers:

- the door frame and architrave installation position relative to the wall.
- the fire stopping between the frame and the wall.
- the fixing requirement including packers.
- the requirements for door edge gaps.
- the trimming of door edges.

### 11.2 Door Frame Installation

The following figures indicate the acceptable door frame installations. Please note that the firestopping element is provided in the below 3D models as a generic red coloured seal. For further clarification of the approved firestopping systems see section 11.3.

Permitted Installations	
	Instances where the door frame and the wall of the same depth such that architraves are fitted flush to both faces. Note that the minimum door frame section size (width and depth) must be as per the requirements noted in this report – see door frame section. Architraves requirements are documented in the firestopping section of this report.
	Instances where the wall thickness is greater than the door frame depth. In this scenario timber architraves of minimum 18mm thick must be fitted to both faces, fitted with a minimum 15mm overlap to the door gap, other than when the architrave abuts the wall.
	Split frames are permitted providing that both frame sections are secured to the wall in accordance with section 11.5. Furthermore, the main frame section (from which the door is hung) must be constructed to at least the minimum door frame section size (width and depth) as per the requirements noted in this report – see door frame section. The extension piece must be constructed using the same timber species as the main frame section.

#### Note:

1. The drawings are provided as a generalised illustration of the door frame installation only; actual installation must be as per the text within this document specifies.
2. When fitted within a masonry construction as detailed in section 11.5 the entire thickness of the leaf shall be within the thickness of the masonry element.

### 11.3 Firestopping

The firestopping requirements between the back of frame and wall are dependent on the gap size between the substrates. The table below provides the requirements based upon the gaps size. Please note that in the 3D depictions noted below show the application where a door frame is of the same depth as the overall wall thickness.

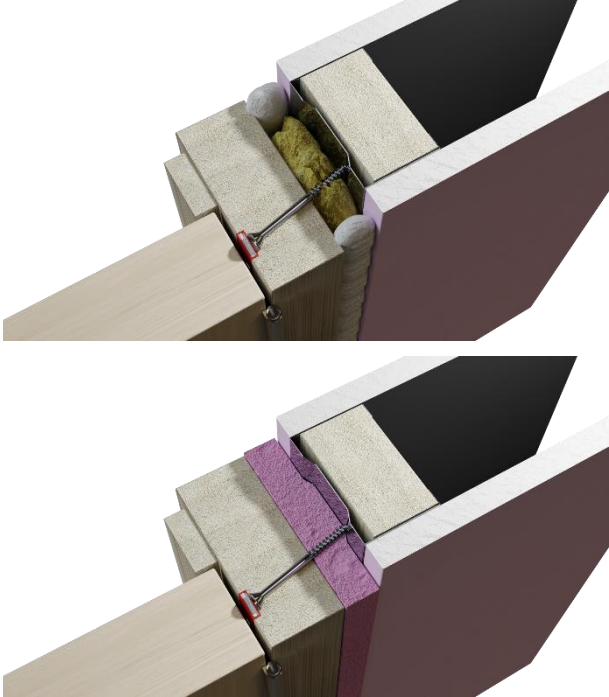
Gap (mm)	Requirement	3D model depiction
0 – 2	In practice, unlikely to occur, but if present, must be sealed with architraves, as below, fitted over a bead of acrylic intumescent sealant, tested as below.	N/A
3 – 10	Gap must be sealed on both sides with a 10mm depth of acrylic intumescent mastic, fire tested for this application to BS 476 Part 22: 1987 or BS EN 1634-1.  Timber architraves of a minimum 15mm thick must be fitted to both faces, fitted with a minimum 15mm overlap to the door gap.	
10 – 20	Gap must be tightly packed with mineral fibre capped on both sides with a 10mm depth of acrylic intumescent mastic, fire tested for this application to BS 476: Part 22: 1987 or BS EN 1634-1 or full depth expanding PU foam, fire tested for this application to BS 476 Part 22: 1987 or BS EN 1634-1.  Timber architraves of a minimum 15mm thick must be fitted to both faces, fitted with a minimum 15mm overlap to the door gap.	

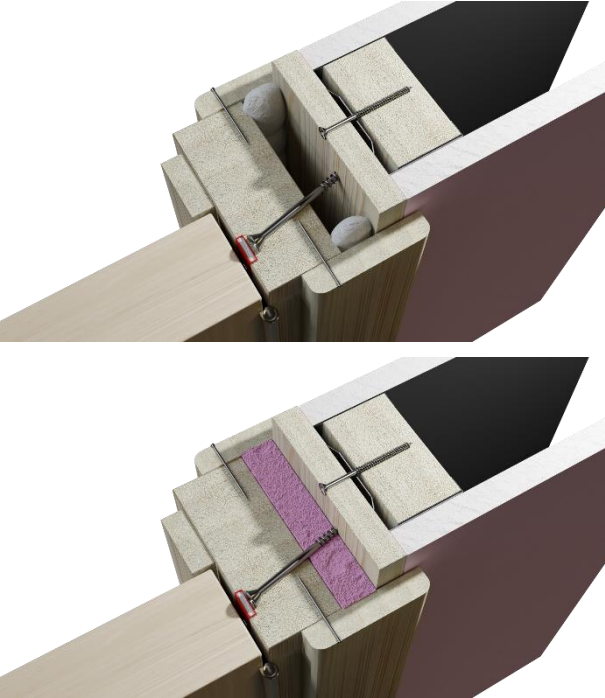
Gap (mm)	Requirement	3D model depiction
Over 20	<p>This would be considered a poor preparation of the structural opening. A timber based or non-combustible subframe up to 50mm thick can be inserted and fixed to the wall bedded on intumescent mastic, the gap between door frame and subframe filled as follows:</p> <p>Gaps 5 to 10mm filled on both sides with 10mm depth of acrylic intumescent mastic or full depth expanding PU foam, fire tested for this application to BS 476 Part 22: 1987 or BS EN 1634-1.</p> <p>Timber architraves of a minimum 15mm thick must be fitted to both faces, fitted with a minimum 15mm overlap to the door gap.</p>	

#### 11.4 Packers

Packers can be timber of equal density to the frame, or plywood or plastic packers if fire tested for this application to BS 476: Part 22: 1987 or BS EN 1634-1.

## 11.5 Wall Types, Structural Opening & Fixity

### 11.5.1 Wall Types

The following wall types are approved for this doorset design:

- a) Plasterboard clad timber stud partitions
- b) Plasterboard clad steel stud partitions including timber lining.
- c) Masonry constructions

Wall types a & b above must have supporting fire resistance test evidence which demonstrates that it is capable of staying in place and intact for a minimum of 30 minutes supporting a doorset design.

Wall type c above must be determined to be able to provide at least the same level of fire resistance of the doorset design.

All wall types detailed above shall provide a suitable medium to permit adequate fixity, it is anticipated that for:

- Plasterboard clad timber stud partitions, the timber stud will be of sufficient dimensions such that the fixing for the door frame penetrates into solid timber.
- Plasterboard clad steel stud partitions will include a timber lining of sufficient dimensions such that the fixing for the door frame penetrates into solid timber.
- Masonry constructions are anticipated to be constructed of a solid block or brickwork to receive the fixings.

**Note:** Other tested solutions to achieve adequate fixity may be detailed within the above noted supporting fire resistance test evidence.

### 11.5.2 Structural Opening

For all wall types the structural opening shall be square, plumb and provide a flat surface for installation of the doorset.

For flexible wall types such as steel and timber stud partitions the structural opening must be prepared in line with the test evidence provided by the wall manufacturer.

### 11.5.3 Fixings

In all instances the fixing position must be such that it provides adequate restraint to the element of construction throughout the exposure to fire. This may therefore sometimes necessitate a twin line of fixings.

The positioning of installation fixings in height should be planned to avoid conflicts with hardware, sealing systems and other building elements.

- A top fixing must be located within 100mm from the underside of the head.
- A bottom fixing must be located 100mm from the bottom of the jamb.
- Intermediate fixings must be located at centres of not more than 600mm.

**The minimum number of fixings in height must be:**

- Doorset height up to 2000mm = 4 fixings
- Doorset height 2000 – 2500mm 2350mm = 5 fixings
- Add 1No. additional fixing for each further 500mm increase in door height.

## Notes:

- The fixings must be of the appropriate type for the supporting construction and must penetrate to a minimum depth of 40mm.
- For storey height doorsets a top fixing must be provided within 100mm from the underside of the frame head with a further top fixing positioned 100mm from the underside of the transom rail (or bottom edge of the over panel if a flush overpanel design is used).
- For single leaf doorsets, it is not necessary to fix the frame head, although packers must be inserted. However, for doorset widths in excess of 1100mm the use of an additional fixing at centre width of the doorset at the head position is recommended.
- For all other configurations of doorset, the upper horizontal framing section abutting the structural opening must be secured to the wall using steel fixings at 600mm maximum centres and maximum of 150mm from corner. The fixings must be of the appropriate type for the supporting construction and must penetrate to a minimum depth of 50mm.
- MDF frames are more flexible than timber frames. To reduce the risk of frame distortion during fixing it is strongly recommended that the dimension for fixing centres between intermediate fixings is reduced from 600mm to a maximum of 500mm.

See following diagram for illustration on fixings for a typical timber door frame doorset installation.

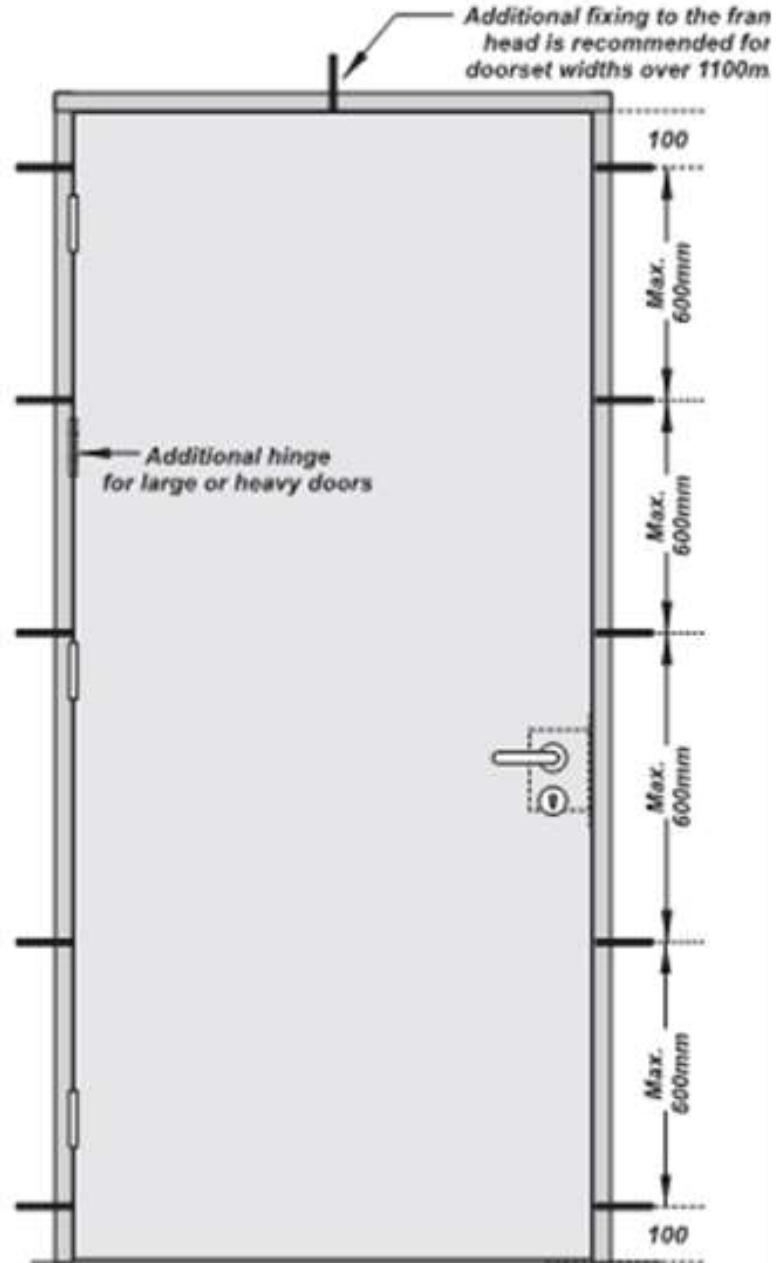

**Timber frame fixing locations illustrated.**

### 11.6 Post Production (Onsite) Leaf Size Adjustment

The Flamebreak range of doorsets may be altered as follows:

Leaf Size Adjustment Specification	
Element	Reduction
Lipping	The post-production lipping thickness may be reduced by 1mm for fitting purposes, providing that the door gaps and intumescent conditions remain as required by this assessment and the minimum limitation in terms of lipping thickness is still maintained



## 11.7 Door Gaps

Door gaps and alignment tolerances must fall within the following range:

Door Gap & Alignment Tolerance Specification	
Location	Dimension
Door edge gaps	A minimum of 2mm and a maximum of 4mm
Alignment tolerances	Leaves must not be proud of each other or from the door frame by more than 1mm.
Threshold/Bottom edge of the leaf  This is the maximum tolerance for fire resistance only.	8mm between bottom of leaf and top of floor covering.  The specific gap requirements, as detailed in section 7.2, take precedence:

## 12 Insulation Performance

Insulation performance may be claimed for a doorset to this design meeting the following:

Insulation Performance Criteria	
Type	Details
Partially insulating	Doorsets incorporating up to 20% of non-insulating glazing
Fully insulating	Unglazed doorsets or doorsets including 30-minute insulating glazing (e.g. 15mm Pyrostop or 16mm Pyrobel), see section 6

## 13 Conclusion

If the Pacific Rim Wood Ltd. Flamebreak 30 door leaf designs, constructed in accordance with the specification documented in this field of application were to be tested in accordance with BS 476 Part 22: 1987, it is our opinion that they would provide a minimum of 30 minutes integrity and insulation (subject to section 12).

## 14 Declaration by the Applicant

- 1) We the undersigned confirm that we have read and comply with obligations placed on us by the Passive Fire Protection Forum (PFPF) Guide to undertaking technical assessments and engineering evaluations based on fire test evidence 2021 Industry Standard Procedure
- 2) We confirm that any changes to a component or element of structure which are the subject of this assessment have not to our knowledge been tested to the standard against which this assessment has been made.
- 3) We agree to withdraw this assessment from circulation should the component or element of structure, or any of its component parts be the subject of a failed fire resistance test to the standard against which this assessment is being made.
- 4) We understand that this assessment is based on test evidence and will be withdrawn should evidence become available that causes the conclusion to be questioned. In that case, we accept that new test evidence may be required.
- 5) We are not aware of any information that could affect the conclusions of this assessment. If we subsequently become aware of any such information, we agree to ask the assessing authority to withdraw the assessment.

(In accordance with the principles of FTSG Resolution No. 82: 2001)

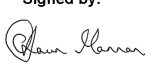
Signed by:   
Signed: \_\_\_\_\_  
33AD470DA5E54DF...

Name: Shaun Hannan  
\_\_\_\_\_

Position: Company Secretary  
\_\_\_\_\_

Date: 03-Sep-2024  
\_\_\_\_\_

For and on behalf of: **Pacific Rim Wood Ltd.**



## 15 Limitations

The following limitations apply to this assessment:

- 1) This field of application addresses itself solely to the elements and subjects discussed and do not cover any other criteria or modifications. All other details not specifically referred to should remain as tested or assessed.
- 2) This field of application report is issued on the basis of test data and information to hand at the time of issue. If contradictory evidence becomes available to Warringtonfire, the assessment will be unconditionally withdrawn, and the applicant will be notified in writing. Similarly, the assessment evaluation is invalidated if the assessed construction is subsequently tested since actual test data is deemed to take precedence.
- 3) This field of application has been carried out in accordance with Fire Test Study Group Resolution No. 82: 2001.
- 4) Opinions and interpretation expressed herein are outside the scope of UKAS accreditation.
- 5) This field of application relates only to those aspects of design, materials and construction that influence the performance of the element(s) under fire resistance test conditions against the ISO 834 time/temperature curve that is stipulated in the standard this assessment concludes to. It does not purport to be a complete specification ensuring fitness for purpose and long-term serviceability. It is the responsibility of the client to ensure that the element conforms to recognised good practice in all other respects and that, with the incorporation of the guidance given in this field of application, the element is suitable for its intended purpose.
- 6) This field of application report represents our opinion as to the performance likely to be demonstrated on a test in accordance with BS476 Part 22: 1987, on the basis of the test evidence referred to in this report. We express no opinion as to whether that evidence, and/or this field of application would be regarded by any Building Control authorities or any other third parties as sufficient for that or any other purpose.
- 7) This report may only be reproduced in full. Extracts or abridgements of reports shall not be published without permission of Warringtonfire. All work and services carried out by Warringtonfire Testing and Certification Limited are subject to, and conducted in accordance with, the Standard Terms and Conditions of Warringtonfire Testing and Certification Limited, which are available at <https://www.element.com/terms/terms-and-conditions> or upon request.
- 8) The version/revision stated on the front of this field of application supersedes all previous versions/revisions and must be used to manufacture doorsets from the stated validity date on this front cover. Previous revisions of the Field of Application cannot be used once an updated Field of Application has been issued under a new revision.

## 16 Validity

- 1) The assessment is initially valid for five years after which time it is recommended to be submitted to Warringtonfire for re-appraisal.
- 2) This assessment report is not valid unless it incorporates the declaration given in Section 14 duly signed by the applicant.

<b>Position:</b>	<b>Assessor</b>	<b>Reviewer</b>
<b>Signature:</b>	 <p>Signed by:  <small>DE15B987D373423...</small></p>	 <p>Signed by:  <small>DE5B8657DAF149D...</small></p>
<b>Name:</b>	<b>*A M Winning</b>	<b>*E Power</b>
<b>Title:</b>	Senior Product Assessor	Product Assessor

\* For and on behalf of Warringtonfire

## Appendix A: Summaries of Supporting Test Evidence

### 16.1 Test Report 18-003111-PR04

The referenced test report, the essential details of which are summarised below is presented as primary test data for the Flamebreak 430 design incorporating a Winkhaus AV-2 auto-locking 3-pt lock.

<b>Date of test</b>	23 <sup>rd</sup> October 2018
<b>Identification of test body</b>	Rosenheim IFT GmbH, Theodor-Gietl-Strasse 7-9, D-83026, Rosenheim. EG reference No: 0757
<b>Sponsor</b>	Pacific Rim Wood Ltd
<b>Tested Product</b>	A latched, single acting, single leaf, timber based doorset.
<b>Summary of test specimen</b>	<p><b>Leaf dimensions:</b> 2150 (h) x 926 (w) x 44 (t).</p> <p><b>Core:</b> Leaf comprised of a Flamebreak '430', all edges of the leaf were lipped with 8mm (t) Sapele of nominal density 640kg/m<sup>3</sup> fixed to all edges, stiles and bottom rail were removed; head rail remained in place as described in section 5.1. Facings were 4mm thick Plywood.</p> <p><b>Door frame:</b> European Redwood at 32mm thick, nominal density 510kg/m<sup>3</sup> with MDF architrave on both faces. Threshold: Stormguard Slimline protected with ST302 graphite liner.</p> <p><b>Intumescent Seals:</b> 1No. 15 x 4mm STS 154FO PVC encased intumescent strip was fitted centrally into the frame head and jambs. 1mm thick STS graphite sheet 'ST Graphite' was fitted encasing the hook bolt bodies and behind the striker plates with STS 'ST30 graphite lock kit protecting the centre lock body.</p> <p><b>Hardware:</b> 4No. Union steel lift off hinges ref: 605, together with a Winkhaus AV-2 auto-locking 3-pt lock with an ERA FAB &amp; Fix zinc handleset and UAP Kinetica cylinder. A surface mounted Eclipse 28730 overhead door closer, was fitted to the exposed face of the leaf.</p> <p>The doorset was oriented to open in towards the furnace.</p> <p><b>Glass:</b> 'Pyrobelite' IGU 167(w) x 892(h) comprised of 7mm (t) Pyrobelite/8mm (t) steel spacer/6.8mm (t) laminate glass with Pyrobelite oriented to the fire risk side.</p> <p><b>Glazing system:</b> STS 105GT either side of the glass protecting hardwood beads 25 (w) x 16mm (h) with a 5 x 5mm bolection return, beads fixed with 50mm long steel pins installed at 50mm from corners and at 150mm centres, aperture lined with ST302 liner.</p>
<b>Test Standard</b>	BS 476 Part 22:1987
<b>Performance</b>	Integrity: 34; Insulation: 29

## 16.2 Test Report WF403587 Specimen A

The referenced test report, the essential details of which are summarised below, is supporting data for the door design being considered for assessment in this report. This test demonstrates the performance of the Flamebreak 30 design opening away from the heating conditions of the furnace.

<b>Date of test</b>	20 <sup>th</sup> August 2018
<b>Identification of test body</b>	Warringtonfire Testing UKAS ref: 1762
<b>Sponsor</b>	Sealed Tight Solutions Ltd
<b>Tested Product</b>	Unlatched, single acting, double leaf, timber based doorset.
<b>Summary of test specimen</b>	<p><b>Leaf dimensions:</b> 2040 (h) x 826 (w) x 44 (t).</p> <p><b>Core:</b> Leaf comprised of a Flamebreak '430', all edges of the leaf were lipped with 6mm (t) Sapele of nominal density 640kg/m<sup>3</sup>. Facings were 4mm thick Plywood.</p> <p><b>Door frame:</b> European Redwood at 30mm thick, nominal density 510kg/m<sup>3</sup> with Redwood architraves on both faces.</p> <p><b>Intumescent Seals:</b> 1No. 15 x 4mm STS 154FO PVC encased intumescent strip was fitted centrally into the frame head and jambs. No other intumescent materials were fitted.</p> <p><b>Hardware:</b> 3No. Jedo steel bearing butt hinges ref: 102, together with a Herbine lever operated mortice latch with a 235mm high forend, disengaged for the test. A surface mounted Synergy s800 EN2-5 overhead door closer, was fitted to the unexposed face of the leaf.</p> <p>The doorset was oriented to open away from the furnace.</p>
<b>Test Standard</b>	BS 476 Part 22:1987
<b>Performance</b>	Integrity: 47 Insulation: 47

### 16.3 Test Report WF381914 Specimen B

The referenced test report, the essential details of which are summarised below, is primary data for the door design being considered for assessment in this report when used with Sealed Tight Solutions leaf edge seals. Specimen B in this test supports assessment of the Flamebreak 30 doorset constructions, in latched and unlatched single acting, single and double leaf doorsets.

<b>Date of test</b>	6 <sup>th</sup> April 2017
<b>Identification of test body</b>	Exova Warringtonfire Fire (now trading as Warringtonfire Testing) UKAS ref: 1762
<b>Sponsor</b>	Sealed Tight Solutions Ltd, Units 1B & 1C Princes Court, Low Prudhoe Industrial Estate, Prudhoe, Northumberland, NE42 6PL
<b>Tested Product</b>	Specimen B comprised an unlatched, single acting, double leaf, timber based doorset.
<b>Summary of test specimen</b>	<p><b>Leaf dimensions:</b> 2155 (h) x 936/680 (w) x 44 (t).</p> <p><b>Core:</b> both leaves comprised of Flamebreak 430, all edges of the leaves were lipped with 10mm (t) Sapele of nominal density 640kg/m<sup>3</sup>. Facings were 4mm thick Plywood with 2 deep x 10 wide grooves running to the leaf edge.</p> <p><b>Door frame:</b> European Redwood at 32mm thick, nominal density 510kg/m<sup>3</sup> with MDF architrave on both faces.</p> <p><b>Intumescent Seals:</b> 1No. 15 x 4mm STS 154FO PVC encased intumescent strip was fitted centrally into the frame head and jambs, with 2No 10 x 4mm STS 104FO fitted 10mm apart, 5mm either side of the centreline in one meeting edge. 1mm thick STS graphite sheet was fitted under all hinge blades, encasing the latch body, under the latch forend and keep and protecting the flush bolts.</p> <p><b>Hardware:</b> 3No. Eurospec steel bearing butt type hinges per leaf, together with a lever operated mortice latch with a 230mm high forend, disengaged for the test. A surface mounted Arrone AR1500 overhead door closer, was fitted to the exposed face of the leaves with Zoo Hardware ZAS03SS flush bolts in one meeting edge at head and threshold.</p> <p>The doorset was oriented to open in towards the furnace.</p>
<b>Test Standard</b>	BS 476 Part 22:1987
<b>Performance</b>	Specimen B: Integrity: 44; Insulation: 44

## 16.4 Test report WF522957

The referenced test report, the essential details of which are summarised below, is primary data for the door design being considered for assessment in this report when used with Rutland concealed closers and also demonstrates the successful use of multiple glazed apertures and also includes sampled evidence relating to 'T'-shaped lippings.

<b>Date of test</b>	7 <sup>th</sup> October 2022
<b>Identification of test body</b>	Warringtonfire Testing UKAS ref: 1762
<b>Sponsor</b>	Rutland UK
<b>Tested Product</b>	2No Latched, single acting, single leaf, timber based doorsets. Doorset A tested opening out, away from the furnace Doorset B tested opening in, towards the furnace
<b>Summary of test specimen</b>	Both specimens identical apart from minor leaf size dimensions. <b>Leaf dimensions:</b> A:2045 & B:2047 (h) x A:927 & B:929 (w) x 44 (t). <b>Core, both :</b> Leaf comprised of a Flamebreak '430', all edges of the leaf were lipped with 44mm (w) x 16mm (t) hardwood of nominal density 640kg/m <sup>3</sup> ., lippings incorporated a 25mm (w) x 8mm (t) tongue to locate into the core Facings were 4mm thick Plywood. <b>Door frame:</b> European Redwood at 34mm thick, nominal density 510kg/m <sup>3</sup> with 12mm high planted stop and Redwood architraves on both faces. <b>Intumescent Seals:</b> 1No. 15 x 4mm Sparka PVC encased intumescent strip ref: TU1012.WHT was fitted centrally into the frame head and jambs. <b>Hardware:</b> 3No. Sparka steel bearing butt hinges ref: HG1010.SSS, together with a Sparka lever operated mortice latch with a 235mm high forend, engaged for the test, a Sparka letterplate ref: LE1013.SCP, 2No Sparka eye viewers ref: BA1013.SCP and a Sparka dropseal ref: TU1218. A concealed, Rutland ITS11204 concealed door closer, was fitted at the head of the leaf.
<b>Test Standard</b>	BS EN 1634-1:2014+A1:2018
<b>Performance</b>	Integrity: 36, no failures of integrity criteria were recorded prior to termination of test Insulation: Doorset A: 10 minutes; doorset B: 8 minutes



## 16.5 Test report WF535889

The referenced test report, the essential details of which are summarised below, is primary data for the door design being considered for assessment in this report when installed with a multipoint lockset and multiple locksets and when installed with fanlight and sidelights.

<b>Date of test</b>	23 <sup>rd</sup> August 2023
<b>Identification of test body</b>	Warringtonfire Testing UKAS ref: 1762
<b>Sponsor</b>	Wood International Agency Limited, Wood House, 16 King Edward Road, Brentwood, Essex, CM14 4HL.
<b>Tested Product</b>	2No single acting, single leaf, timber based doorsets mounted within a common glazed screen. Doorset A: LSASD tested opening in, towards the furnace Doorset B: ULSASD tested opening in, towards the furnace
<b>Summary of test specimen</b>	<p><b>Leaf dimensions: A &amp; B:</b> 2040 x 926 (w) x 44 (t).</p> <p><b>Core, A &amp; B:</b> Leaf comprised of a Flamebreak '430', all edges of the leaf were lipped with 44mm (w) x 8mm (t) hardwood of nominal density 640kg/m<sup>3</sup>, lippings incorporated a 25mm (w) x 6mm (t) tongue to locate into the core Facings were 4mm thick Plywood.</p> <p><b>Door frame, A &amp; B:</b> Engineered Redwood at 47mm thick, nominal density 510kg/m<sup>3</sup> with 18mm high planted stop and Redwood architraves on both faces.</p> <p><b>Intumescent Seals:</b></p> <p><b>A:</b> 2No. 10 x 4mm Lorient Polyproducts Type 617 PVC encased intumescent fitted centrally 10mm apart into the frame head and jambs.</p> <p><b>B:</b> 1No. 15 x 4mm Lorient Polyproducts Type 617 PVC encased intumescent strip fitted centrally into the frame head and jambs.</p> <p><b>Hardware, A &amp; B:</b> 3No. Arrone A8182 steel bearing butt hinges, an Arrone AR1500 face fixed closer, a Norseal NOR810 dropseal centrally in the leaf threshold. BM TRADA – 'Q-Mark plug' Door Data Systems – Data tag.</p> <p><b>A:</b> A Winkhaus AV2 latch with auto-firing top and bottom hooks and centre latch nib engaged. 1mm thick MAP fitted to cheeks and edges of all lockcases and behind all keeps, no protection to forend.</p> <p><b>B:</b> An Arrone AR8004 latch with a 156mm high forend was fitted at 1018mm above the threshold. Protected with 1mm thick Interdens to the cheeks and edges of the lockcase and behind the forend, no protection to forend or keep. A Carlisle Brass LFB2SSS latch with a 118mm high forend was fitted at 1318mm above the threshold. Protected with 1mm thick Interdens to the cheeks and edges of the lockcase and behind the forend and keep. 2No UAP eye viewers ref: SWALF fitted 100mm apart with the top viewer</p>

	<p>576mm from the head of the leaf, protected with 1mm thick gaskets supplied with the eye viewers.</p> <p><b>Glazing:</b></p> <p><b>A:</b> AGC Pyrobelite 9EG, aperture size 1406 (h) x 406(w); hardwood beads nominal density 640kg/m<sup>3</sup> @ 19.5(w) x 15.75(h) with 3.8 x 3.65 bolection and 15 degree top chamfer; 50(l) x 16guage nails; glazing system Sealed Tight Solutions STS 104SG, nominally 15 x 7.</p> <p><b>B:</b> AGC Pyrobelite 7, aperture size 1406 (h) x 406(w); hardwood beads nominal density 640kg/m<sup>3</sup> @ 25(w) x 20(h) with 4 x 7 bolection and 15 degree top chamfer; 50(l) x 16guage nails; glazing system Sealed Tight Solutions STS 104SG, nominally 15 x 7.</p> <p><b>Sidelight:</b></p> <p>Framing: All 4 sides of sidelight between door frames.          Softwood, density 510 kg/m<sup>3</sup>, 70 x 30 (t).          AGC Pyrobelite 7, aperture size 2019 (h) x 500(w); hardwood planted beads nominal density 600kg/m<sup>3</sup> @ 15(w) x 20(h) and 15 degree top chamfer; 31(l) x 3.6mm diameter screws nails; glazing system Sealed Tight Solutions STS 104SG, nominally 15 x 7.</p> <p><b>Fanlight:</b></p> <p>Framing: All 4 sides of fanlight over door frames and sidelight.          Softwood, density 510 kg/m<sup>3</sup>, 70 x 30 (t).          AGC Pyrobelite 7, aperture size 620 (h) x 2484(w); hardwood planted beads nominal density 600kg/m<sup>3</sup> @ 15(w) x 20(h) and 15 degree top chamfer; 31(l) x 3.6mm diameter screws nails; glazing system Sealed Tight Solutions STS 104SG, nominally 15 x 7.</p>
<b>Test Standard</b>	BS EN 1634-1:2014+A1:2018
<b>Performance (Minutes)</b>	<p>Integrity: 39</p> <p>Insulation: Doorset A: 39 (leaf and frame), 29 (glazing).                  Doorset B: 39 (leaf and frame), 11 (glazing).</p> <p>Sidelight &amp; Fanlight: Integrity: 39</p> <p>Insulation: 10.</p>

## 16.6 Test report WF504980

The referenced test report, the essential details of which are summarised below, is presented as supporting data for intumescent materials and hardware items.

<b>Date of test</b>	18 <sup>th</sup> June 2021	
<b>Identification of test body</b>	Warringtonfire Testing UKAS ref: 1762	
<b>Sponsor</b>	Pacific Rim Wood Ltd	
<b>Tested Product</b>	2No Latched, single acting, single leaf, timber based doorsets. Doorset A tested opening in, towards the furnace Doorset B tested opening out, away from the furnace	
<b>Summary of test specimen</b>	<p>Both specimens identical.</p> <p><b>Leaf dimensions:</b> 2150 (h) x 930 (w) x 44 (t).</p> <p><b>Core:</b> Leaf comprised of a Flamebreak '430', all edges of the leaf were lipped with 44mm (w) x 8mm (t) hardwood of nominal density 640kg/m<sup>3</sup> applied over untrimmed stiles and rails. Facings were 4mm thick Plywood.</p> <p><b>Door frame:</b> Sapele hardwood at 59mm thick, nominal density 640kg/m<sup>3</sup> with 15mm high integral stop.</p> <p><b>Cill:</b> Sapele hardwood of nominal density 640kg/m<sup>3</sup> 60mm high 145mm wide with integral 15mm high rebated stop. No architraves fitted.</p> <p><b>Intumescent Seals:</b> 1No. 15 x Pyroplex strip ref: 8712 was fitted centrally into the frame head and jambs. An Aquamac 21 smoke seal was inserted into to the upstand of the stop and a Pyroplex 8712 brush seal in the threshold of the leaf.</p> <p><b>Hardware:</b> 4No. Nico steel bearing butt, together with a Winkhaus AV2 latch with a 235mm high forend, engaged at the centre point only, a UAP letterplate ref: Soterian TS008, a UAP eye viewer. No door closer was fitted.</p>	
<b>Test Standard</b>	BS EN 1634-1:2014+A1:2018	
<b>Performance</b>	Doorset A	Doorset B
	Integrity: 48	Integrity: 35
	Insulation: 43	Insulation: 35

## 16.7 Test report RF98033

The referenced test report, the essential details of which are summarised below, is the primary data for the Flamebreak design utilising Lorient Polyproducts Ltd Type617 seals without lippings installed.

<b>Date of test</b>	14 <sup>th</sup> April 1998
<b>Identification of test body</b>	Warringtonfire (originally Chiltern international fire)
<b>Sponsor</b>	Pacific Rim Wood Ltd
<b>Summary of test specimen</b>	<p><b>Dimensions of leaf:</b> 2135mm (H) x 915mm (W) x 45mm (T)  <b>Core/Lipping</b> Flamebreak leaf with top and bottom rails fitted;  No lipping fitted.</p> <p><b>Intumescent</b> 1No. Lorient Polyproducts LP2004 (20x4) fitted centrally on meeting edges on right leaf.  1No. Lorient Polyproducts LP2004 (20x4) fitted centrally to frame reveal head.  1No. Lorient Polyproducts LP2004 (20x4) fitted centrally frame reveal vertical edges.</p> <p><b>Frame/Facings</b> European redwood 70mm (W) x 32mm (T) with 12.5mm Deep x 24mm wide stop &amp; 12mm (T) plasterboard Architrave  6mm thick Far Eastern Hardwood Plywood facings fixed with melamine based adhesive.</p> <p><b>Hardware</b> 3No. Royde &amp; Tucker H101 lift off type Hinges 100mm x 30mm (blade size)  1No. Dorma Door Controls (TS73V) Overhead Door Closer 220mm x 60mm  1No. Henderson Hardware 63mm (L) Tubular mortice Latch (Disengaged)  Aluminium Lever Handles 102mm (H) x 38mm (W).</p> <p><b>Hardware protection</b>  <b>Glazing</b> Pilkington Pyroshield 6mm thick fitted centrally 150mm from the head of the door leaf,  overall sight size (472mm x 472mm)  overall aperture size (500mm x 500mm)</p> <p><b>Beading</b> Sapele beading with a 15<sup>o</sup> bevel 22mm deep x 13.5mm (H) plus a 5mm (H) bolection return.  40mm (L) steel pin beading fixings at 150mm centres fixed at nominally 35<sup>o</sup> to the glass.  Expansion allowance 2.5mm on all edges.</p> <p><b>Doorset orientated</b> to open towards heating conditions</p>
<b>Test Standard</b>	BS 476: Part 22:1987
<b>Performance</b>	Integrity: 36 Minutes Insulation: 36 Minutes

## 16.8 Test report RF98075

The referenced test report, the essential details of which are summarised below, is the primary data for the Flamebreak design utilising Lorient Polyproducts Ltd Type617 seals with lippings installed on vertical and bottom edges.

<b>Date of test</b>	21 <sup>st</sup> August 1998
<b>Identification of test body</b>	Warringtonfire (originally Chiltern International Fire)
<b>Sponsor</b>	Pacific Rim Wood Ltd
<b>Tested Product</b>	2No. Unlatched, single acting, single leaf Doorset A- left leaf Doorset B- right leaf
<b>Summary of test specimen</b>	<p><b>Dimensions of leaf</b>-Doorset A 2055mm (H) x 865mm (W) x 44mm (T) Doorset B 2135mm (H) x 916mm (W) x 44mm (T)</p> <p><b>Core/Lipping</b> Doorset A: Flamebreak 430 leaf with top rail fitted; 10mm (T) Sapele Lippings on vertical and bottom edges. Doorset B Flamebreak 430 leaf with top and bottom rails fitted; 10mm (T) No lippings fitted.</p> <p><b>Intumescent</b> Both Doorsets frame head &amp; Jambs fitted with Lorient Polyproducts LP1504 intumescent (15x4) fitted centrally.</p> <p><b>Frame/Facings</b> Both doorsets European Redwood head &amp; jambs 70mm (T) x 32mm (W), European redwood planted stops 12mm (D), plasterboard architrave 12.5mm (T), non-combustible threshold. 4mm thick Far Eastern Hardwood Plywood facings fixed with melamine based adhesive.</p> <p><b>Hardware</b> Doorset A 3No. Royde &amp; Tucker H105 lift off type Hinges 100mm x 32mm (blade size) Located 150mm,940mm,1725mm from the head of door leaf. 1No. Dorma Door Controls (TS73V) Overhead Door Closer 233mm x 60mm fitted to exposed face as per manufacturer's instructions. 1No. Henderson Hardware 63mm (L) Tubular mortice Latch (Disengaged) (60mm x 38mm) fitted 1055mm from the head of the leaf centre of the nib. Aluminium Lever Handles 102mm (H) x 38mm (W). fitted 1055mm from the centre of the handle. Doorset B 3No. Royde &amp; Tucker H105 lift off type Hinges 100mm x 32mm (blade size) fitted 150mm,975mm, 1805mm from the head of the door leaf. 1No. Dorma Door Controls (TS73V) Overhead Door Closer 233mm x 60mm fitted to exposed face as per manufacturer's instructions. 1No. Henderson Hardware 63mm (L) Tubular mortice Latch (Disengaged) (60mm x 38mm) fitted 1135mm from the head of the leaf to centre of the nib. Aluminium Lever Handles 102mm (H) x 38mm (W). fitted 1135mm from the head of the leaf to the centre of the handle.</p>

	<p><b>Hardware Protection</b> Both doorsets 2No. Lorient Polyproducts Ltd LP1504 15mm x 4mm intumescent on frame reveal.                  Fully interrupted around hinges.</p> <p><b>Glazing</b> None</p> <p><b>Doorset orientated</b> to open towards heating conditions</p>	
<b>Test Standard</b>	BS 476 Part 22:1987	
<b>Performance</b>	Integrity Doorset A: 31 Minutes Insulation Doorset A: 31 Minutes	Integrity Doorset B: 33 Minutes Insulation Doorset B: 33 minutes

## 16.9 Test report RF00044

The referenced test report, the essential details of which are summarised below, is the primary data for the Flamebreak design with stiles and rails but without lippings.

<b>Date of test</b>	8 <sup>th</sup> May 2000
<b>Identification of test body</b>	Warringtonfire
<b>Sponsor</b>	Pacific Rim Wood Ltd
<b>Summary of test specimen</b>	<p><b>Dimensions of leaf:</b> 2080mm(H) x 915mm x 44mm (T)</p> <p><b>Core/ Lipping</b> Flamebreak 430 leaf with top and bottom rails, and stiles fitted; no lippings installed.</p> <p><b>Intumescent</b> 2No. Lorient Polyproducts LP1504 intumescent strip on head &amp; jambs fitted centrally in rebate of frame.</p> <p><b>Frame/Facings</b> 70mm (W) x 32mm (T) European redwood frame, weight nominal density 510kg/m<sup>3</sup> with 12mm deep pinned stop, 15mm European redwood architrave.</p> <p><b>Hardware</b> 3No. Royde &amp; Tucker HI Load lift off hinges 100mm x 35mm (blade size) fitted 150, 1040 and 1820mm from the head of the leaf.</p> <p>1No. Dorma Door Controls TS73 Overhead Closer 233mm x 60mm footprint, fitted to exposed face as per manufacturer's instructions.</p> <p>Henderson hardware 63mm tubular mortise latch 57mm x 26mm forend size, fitted 1080mm from the head of the leaf to the centre of the nib (disengaged during test)</p> <p>Aluminium lever handle, (100mm x 38mm) fitted 1080 mm from the head of leaf.</p> <p><b>Hardware Protection</b> hinge blade fully interrupts intumescent seal.</p> <p><b>Doorset orientated</b> to open towards heating conditions</p>
<b>Test Standard</b>	BS 476 Part 22:1987
<b>Performance</b>	Integrity: 31 minutes Insulation: 31 minutes

## 16.10 Test report RF00046

The referenced test report, the essential details of which are summarised below, is the primary data for the Flamebreak type 6 design without stiles and with lippings on vertical edges only.

<b>Date of test</b>	12 <sup>th</sup> May 2000
<b>Identification of test body</b>	Warringtonfire (Originally Chiltern International Fire)
<b>Sponsor</b>	Pacific Rim Wood Ltd
<b>Summary of test specimen</b>	<p><b>Dimensions of leaf:</b> 2135mm (H) x 835mm (W) x 44mm (T)</p> <p><b>Core/ Lipping</b> Flamebreak leaf with top and rails fitted; no stiles fitted; 10mm (T) Sapele Lippings vertical edges only.</p> <p><b>Intumescent</b> 3No. Lorient Polyproducts LP2004 (20mm x 4mm) intumescent strip</p> <p><b>Frame/Facings</b> 70mm (W) x 32mm (T) European redwood frame, weight nominal density 510kg/m<sup>3</sup> with 12mm deep pinned stop, 15mm European redwood architrave, 9mm (T) MDF facings fixed with melamine.</p> <p><b>Hardware</b> 3No. Royde &amp; Tucker HI Load lift off hinges 100mm x35mm (blade size) fitted 150,990 and 1835mm from the head of the door.</p> <p>1No. Dorma Door Controls TS73 Overhead Closer 233mm x60mm footprint, fitted to exposed face as per manufacturer's instructions.</p> <p>Henderson hardware 63mm tubular mortise latch 57mm x 26mm forend size, fitted 1140mm from the head of the leaf to the centre of the nib.</p> <p>Aluminium lever handle, (100mm x 35mm) fitted 1100mm from the head of leaf.</p> <p><b>Frame fixings</b> Both doorsets European Redwood head &amp; jambs 72mm (W) x 32mm (T), European redwood planted stops 12mm (D), European redwood architrave 15mm (T), non-combustible threshold.</p> <p><b>Glazing</b> Pilkington Pyroshield 6mm (T) Glazing, located 150mm from the leaf head and 150mm from the hanging edge. Sight Size (570mm x 570mm), Overall aperture Size (600mm x 600mm), expansion allowance 2mm on all edges.</p> <p><b>Beading</b> Sapele, MC 11%, with a 15mm chamfer (15mm (H) x 21mm (D) + a 5mm (D) bolection return, located around perimeter of glass on both faces.</p> <p><b>Beading fixing</b> 40mm long steel pins located at 150mm centres at 45<sup>o</sup> to the face the glass.</p> <p><b>Doorset orientated</b> to open towards heating conditions</p>
<b>Test Standard</b>	BS 476 Part 22:1987
<b>Performance</b>	Integrity: 32 minutes

## 16.11 Test report RF00098

The referenced test report, the essential details of which are summarised below, is the primary data the Flamebreak design with stiles and top rail and without lippings.

<b>Date of test</b>	31 <sup>st</sup> May 2000	
<b>Identification of test body</b>	Warringtonfire (Originally Chiltern International Fire)	
<b>Sponsor</b>	Pacific Rim Wood Ltd	
<b>Tested Product</b>	Doorset A - Left leaf Doorset B- Right Leaf	
<b>Summary of test specimen</b>	<p><b>Dimensions of leaf:</b> Doorset A- 2080mm (H) x 916mm (W) x 44 mm (T), Doorset B -2080mm (H) x 860mm (W) x 44mm (T)</p> <p><b>Core/ Lipping</b> Doorset A- Flamebreak leaf, no Lippings fitted. Doorset B Flamebreak leaf, 8mm (T) Sapele Lippings on vertical edges only fixed with Cascamite.</p> <p><b>Intumescent</b> Doorset A- 2No. Lorient Polyproducts LP1504 intumescent seal (15x4) fitted centrally in frame reveal. Doorset B- 2No. Lorient Polyproducts LP204 intumescent seal (20x4) fitted centrally in the frame reveal.</p> <p><b>Frame/Facings</b> 70mm (T) x 32mm (W) European redwood Head &amp; jambs, weight nominal density 510kg/m<sup>3</sup> with 13mm deep planted stop, 19mm (T) Softwood architrave, 6mm (T) MDF facings fixed with melamine adhesive.</p> <p><b>Hardware</b> Both Doorsets- 3No. Royde &amp;Tucker HI Load lift off hinges 100mm x30mm (blade size) fitted 150, 965 and 1880mm from the head of the door. 1No. Dorma Door Controls TS73 Overhead Closer 233mm x60mm footprint, fitted to exposed face as per manufacturer's instructions. Henderson hardware 63mm tubular mortise latch 57mm x 26mm forend size, fitted 1080mm from the head of the leaf to the centre of the nib. Aluminium lever handle, (100mm x 35mm) fitted 1045mm from the head of leaf.</p> <p><b>Hardware Protection</b> Both Doorsets- intumescent seal fully interrupted by hinge blade.</p> <p><b>Glazing</b> None</p> <p><b>Doorset orientated</b> to open towards heating conditions</p>	
<b>Test Standard</b>	BS 476 Part 22:1987	
<b>Performance</b>	Integrity A: 32 minutes Insulation A: 32 minutes	Integrity B: 33 minutes Insulation B: 33 minutes



## 16.12 Test report RF00166

The referenced test report, the essential details of which are summarised below, is the primary data for the Flamebreak design comparing similar specimens lipped and unlipped.

<b>Date of test</b>	8 <sup>th</sup> January 2001
<b>Identification of test body</b>	Warringtonfire (Originally Chiltern International Fire)
<b>Sponsor</b>	Pacific Rim Wood Ltd
<b>Tested Product</b>	Doorset A - Left leaf Doorset B- Right Leaf
<b>Summary of test specimen</b>	<p><b>Dimensions of leaf:</b> Doorset A- 2440mm(H) x 1220mm (W) x 44mm (T) Doorset B- 2390mm (H) x 1154mm (W) x 44mm (T)</p> <p><b>Core/ Lipping</b> Doorset A- Flamebreak 430. No Lippings fitted. Doorset B- Flamebreak 430, Sapele Lippings on all edges fixed with Cascamite.</p> <p><b>Intumescent</b> Doorset A- 1No. Lorient Polyproducts LP2504 (25x4) mm fitted centrally into the frame reveal. Doorset B- 1No. Lorient Polyproducts LP2504 (25x4) mm fitted centrally into the frame reveal.</p> <p><b>Frame/Facings</b> Doorset A&amp;B: Head and jambs: Sapele 70mm (W) x 32mm (T) Stops: Sapele- Planted (Pinned) 12.5mm (D) Architrave- Sapele 55mm (W) x 18mm (T) Threshold- non-combustible.</p> <p><b>Hardware</b> Doorset A- 4No. Royde &amp; Tucker H101 Lift-off type Hinges (100mm x 35mm) blade size fitted 150,822, 1445, and 2116mm from the head of the leaf. 1No. Dorma Door Controls TS83V Overhead Closer. (293x60) fitted to the exposed face of the leaf as per manufacturer's Instructions. Henderson hardware 63mm Tubular Mortise latch Disengaged during test (57x26) forend size fitted 1440mm from the head of the leaf to the centre of the nib. Aluminium Lever Handles (100mm x 38mm) face plate fitted 1440 from the head of the leaf to the centre of the spindle.</p> <p>Doorset B- 4No. Royde &amp; Tucker H101 Lift-off type Hinges (100mm x 35mm) blade size fitted 150,845, 1443, and 2098mm from the head of the leaf. 1No. Dorma Door Controls TS83V Overhead Closer. (293x60) fitted to the exposed face of the leaf as per manufacturer's Instructions. Henderson hardware 63mm Tubular Mortise latch Disengaged during test (57x26) forend size fitted 1390mm from the head of the leaf to the centre of the nib.</p>

	<p>Aluminium Lever Handles (100mm x 38mm) face plate fitted 1390 from the head of the leaf to the centre of the spindle.</p> <p><b>Hardware Protection</b> Doorset A- Intumescent seal partially interrupted around Hinges with 2mm running continuous past hinge.</p> <p>Doorset B- Intumescent seal fully interrupted around hinges.</p> <p><b>Doorset orientated</b> both leaves are to open towards heating conditions.</p>	
<b>Test Standard</b>	BS 476 Part 22:1987	
<b>Performance</b>	Integrity A: 37 minutes Insulation A: 37 minutes	Integrity B: 41 minutes Insulation B: 41 minutes

## 16.13 Test report RF04011

The referenced test report, the essential details of which are summarised below, is supporting data for Flamebreak design utilising graphite seals with lippings on all edges.

<b>Date of test</b>	21 <sup>st</sup> January 2004
<b>Identification of test body</b>	Warringtonfire (Originally Chiltern International Fire)
<b>Sponsor</b>	Benson Ltd
<b>Summary of test specimen</b>	<p><b>Dimensions of leaf:</b> 1976mm (H) x 758mm (W) x 44mm (T)</p> <p><b>Core/ Lipping</b> Pacific Rim Wood Ltd. Flamebreak leaf, lippings on all edges.</p> <p><b>Intumescent</b> PVC encased graphite product reference unknown or identified by sponsor on head of frame reveal (20x4) mm fitted centrally within the frame reveal.</p> <p>PVC encased graphite product reference unknown or identified by sponsor on head of frame reveal (10x4)mm.</p> <p><b>Frame/Facings</b> Head &amp; Jambs- European Redwood 38mm (T) x 114mm (W)</p> <p>Stops- European Redwood 38mm (T) x 114mm (W)</p> <p>Architrave- 16mm (T)</p> <p>Threshold- Non-Combustible</p> <p><b>Hardware</b> 3No. Stainless steel bearing butt Hinge product reference unknown or identified by sponsor 101mm (H) x 32mm (W) blade size, fitted 150, 902 and 1652mm from the head of the leaf.</p> <p>1No. Dorma door controls TS73V overhead closer.</p> <p>1No. Nemeff latch engaged during test 235mm x 20mm wide forend size, fitted 1090 from the head of the leaf to the centre nib.</p> <p>1No. eclipse stainless steel lever type with rose 45° fitted appropriate to the latch.</p> <p><b>Hardware Protection</b> Intumescent seal fully interrupted by hinge blade.</p> <p><b>Doorset orientated</b> to open towards heating conditions.</p>
<b>Test Standard</b>	BS 476 Part 22:1987
<b>Performance</b>	Integrity: 31 minutes Insulation:31 minutes

## 16.14 Test report RF05041

The referenced test report, the essential details of which are summarised below, is presented as supporting data with specimen having stiles removed & lipped on vertical edges only with rebated meeting edges.

<b>Date of test</b>	16 <sup>th</sup> August 2005
<b>Identification of test body</b>	Warringtonfire (originally Chiltern international fire)
<b>Sponsor</b>	Pacific Rim Wood Ltd
<b>Summary of test specimen</b>	<p><b>Dimensions of leaf:</b> 2041mm (H) x 825mm (W) x 44mm (T)</p> <p><b>Core/Lipping:</b> Flamebreak 430 leaf with top rail and stile on lock edge only; 10mm (T) Sapele Lippings on vertical and bottom edges.</p> <p><b>Intumescent</b> Lorient Polyproducts Intumescent LP1004 10mm X 4mm fitted centrally in the rebate of each leaf.</p> <p>Lorient Polyproducts Intumescent LP2004 20mm x 4mm fitted centrally in the frame reveal.</p> <p><b>Frame/Facings</b> European Redwood 70mm (W) x 32mm (T) Head &amp; Jambs, European redwood 20mm (W) x 12mm (D) planted stops, Rock fibre fire stopping, European redwood 18mm (T) architrave, non-combustible threshold.</p> <p>4mm (T) plywood Facings.</p> <p><b>Hardware</b> 3No. Royde &amp; Tucker HI Load lift off hinges 100mm x 30mm (blade size) fitted 150, 955 and 1760mm from the head of the door.</p> <p>1No. Dorma Door Controls TS73 Overhead Closer 233mm x 60mm footprint, fitted to exposed face as per manufacturer's instructions.</p> <p>E*S 63mm tubular mortise latch 57mm x 26mm forend size, fitted 1040mm from the head of the leaf- disengaged.</p> <p>Aluminium lever handle, (100mm x 35mm) fitted appropriate to the latch.</p> <p><b>Hardware Protection</b> Intumescent seal fully interrupted around Hinges.</p> <p>Dufaylite Interdens 1mm (T) fitted under each hinge blade on both the leaf and the frame.</p> <p>Dufaylite Interdens fitted under the latch forend and under latch keep.</p> <p><b>Frame fixings</b> 3No. 80mm (L) Steel wood screws per Jamb.</p> <p><b>Doorset orientated</b> to open towards heating conditions</p>
<b>Test Standard</b>	BS 476 Part 22:1987
<b>Performance</b>	Integrity: 39 Minutes Insulation: 39 Minutes

## 16.15 Test report R08100

The referenced test report, the essential details of which are summarised below, is presented as supporting data with specimen utilising P.U glueline for lipping, glazed apertures – ply and MDF faces.

<b>Date of test</b>	23 <sup>rd</sup> July 2008
<b>Identification of test body</b>	Warringtonfire (originally Chiltern international fire)
<b>Sponsor</b>	Pacific Rim Wood Ltd
<b>Tested Product</b>	Doorset A – Left specimen ULSADD Doorset B – Right specimen ULSASD
<b>Summary of test specimen</b>	<p><b>Dimensions of leaf:</b> Doorset A – 2100mm (H) x 900/350mm (W) x 44mm (T) Doorset B- 2100mm (H) x 900mm (W) x 44mm (T)</p> <p><b>Core/ Lipping</b> Pacific Rim Wood Ltd Flamebreak FF630 (MDF faces). Sapele Lippings 8mm (T) on all edges. Doorset B Pacific Rim Wood Ltd Flamebreak 430 (Plywood faces), Sapele Lippings 8mm (T) on all edges.</p> <p><b>Intumescent</b> Doorset A- Lorient Polyproducts LP2004 Type 617 intumescent 20mm x 4mm fitted centrally in the meeting edge of left leaf. Lorient Polyproducts LP2004 Type 617 intumescent 20mm x 4mm fitted centrally in the frame reveal. Doorset B Lorient Polyproducts LP1504 Type 617 15mm x 4mm intumescent fitted centrally in the frame reveal.</p> <p><b>Frame/Facings</b> European Redwood 70mm (D) x 32mm (T) Head &amp; Jambs, European redwood 12mm (D) x 14mm (W) planted stops, Mann McGowan Fabrications Ltd Pyromas intumescent acrylic mastic, European redwood 18mm (T) architrave, non-combustible threshold.</p> <p><b>Hardware</b> Both Doorsets Royde &amp; Tucker HI Load lift off hinges 100mm x30mm (blade size) fitted 150, 1000 and 1820mm from the head of the door. 1No. Dorma Door Controls TS73 Overhead Closer 233mm x60mm footprint, fitted to exposed face as per manufacturer's instructions. E*S 63mm tubular mortise latch 57mm x 26mm forend size, fitted 1040mm from the head of the leaf. Aluminium lever handle, (100mm x 35mm) fitted appropriate to the latch. - disengaged.</p> <p><b>Hardware Protection</b> Doorset A- intumescent fully interrupted around hinges. Lorient Polyproducts MAP paper 1mm (T) fitted under the Hinge blade.</p>

	<p>Lorient Polyproducts MAP paper 1mm (T) fitted Around the Body of the latch.</p> <p>Lorient Polyproducts MAP paper 1mm (T) fitted under the latch Forend.</p> <p>Lorient Polyproducts MAP paper 1mm (T) fitted under the Latch Keep</p> <p>Doorset B- Lorient Polyproducts MAP paper 1mm (T) fitted under Hinge Blade.</p> <p>Lorient Polyproducts MAP paper 1mm (T) fitted around the Body of the latch.</p> <p>Lorient Polyproducts MAP paper 1mm (T) fitted under Latch forend.</p> <p>Lorient Polyproducts MAP paper 1mm (T) fitted under Latch Keep.</p> <p>Intumescent fully interrupted by Hinge blade on frame and Jamb.</p> <p><b>Frame fixings-</b> 3No. steel Woodscrews per Jamb 80mm (L).</p> <p><b>Glazing-</b> Pilkington Pyroshield 7mm (T) glass          1040mm (H) x 700mm (W) overall Aperture size</p> <p><b>Beading</b> Sapele 20mm (H) x 22mm deep including a 5x5mm bolection return and 20° chamfer.</p> <p><b>Doorset orientated</b> to open towards heating conditions</p>	
<b>Test Standard</b>	BS 476 Part 22:1987	
<b>Performance</b>	Integrity: 39 Minutes Insulation: 39 Minutes	Integrity: 51 Minutes Insulation: 0 minutes

## 16.16 Test report RF08116

The referenced test report, the essential details of which are summarised below, is the supporting data with specimen utilising 10 x 4 Pyroplex seals with ply and MDF faces.

<b>Date of test</b>	1 <sup>st</sup> September 2008	
<b>Identification of test body</b>	Warringtonfire (Originally Chiltern international Fire)	
<b>Sponsor</b>	Pyroplex Limited	
<b>Summary of test specimen</b>	<p><b>Core/ Lipping</b> Doorset A- Pacific Rim Wood Ltd Flamebreak FF630 (MDF faces), 8mm (T) Sapele Lippings on vertical edges only. Doorset B- Pacific Rim Wood Ltd F Flamebreak 430 (plywood faces). Sapele Lippings on vertical edges only.</p> <p><b>Both Doorsets:</b></p> <p><b>Intumescent-</b> Pyroplex 8500 Rigid box seal 10mm x 4mm fitted centrally in the frame reveal.</p> <p><b>Hardware:</b> 3No. Royde and Tucker Hi Load 101 lift off type hinge 100mm x 35mm Fitted 150mm, 950mm and 1760mm from the head of the leaf. 1No. Dorma UK Ltd TS71 overhead type closer 233mm x 60mm footprint size Fitted on the exposed face as per the manufacturer's instructions. 1No. Euro Star steel tubular mortise latch 57mm x 26mm Fitted 1045mm from the head of the leaf. 1No. Aluminium lever type handle 100mm x 38mm (footprint size) Fitted appropriate to the latch.</p> <p><b>Hardware Protection</b> Around hinges- Hinge blade fully interrupts seal on frame jamb. Around latch keep- Latch keep fully interrupts seal on frame jamb.</p> <p><b>Frame fixings</b> 3No. steel woodscrews per jamb 100mm (L) <b>Doorsets orientated</b> to open towards heating conditions</p>	
<b>Test Standard</b>	BS 476 Part 22:1987	
<b>Performance</b>	Specimen A	Specimen B
	Integrity: 45 Minutes Insulation: 45 Minutes	Integrity: 35 Minutes Insulation: 35 Minutes

## 16.17 Test report RF08118

The referenced test report, the essential details of which are summarised below, is the primary data for the Flamebreak design - specimen comprised ply face leaves with flush overpanel and rebated head junction using Pyroplex seals.

<b>Date of test</b>	3 <sup>rd</sup> September 2008
<b>Identification of test body</b>	Warringtonfire (originally Chiltern international fire)
<b>Sponsor</b>	Pyroplex Limited
<b>Summary of test specimen</b>	<p><b>Dimensions of leaf:</b> 2400mm (H) x 1000mm (W) x 44mm (T)</p> <p><b>Core/ Lipping</b> Pacific Rim Wood Ltd Flamebreak 430 with rebated Sapele lippings on head of leaf only.</p> <p><b>Overpanel</b> Pacific Rim Wood Ltd Flamebreak 430 with rebated Sapele lippings on bottom edge only.</p> <p><b>Intumescent</b> Pyroplex Rigid Box 8500 10mm x 4mm fitted centrally in the rebate of the leaf.</p> <p>2No. Pyroplex Rigid Box 8500 10mm x 4mm fitted centrally 10mm apart in the meeting edge of the right leaf only.</p> <p>2No. Pyroplex Rigid Box 8500 10mm x 4mm fitted centrally 10mm apart in the frame reveal.</p> <p>No. Pyroplex Rigid Box 8500 10mm x 4mm fitted centrally in the rebate of the Overpanel.</p> <p><b>Frame/Facings</b> Head and jambs European redwood 32mm (T) x 70mm Deep, Nominal weight density 510kg/m<sup>3</sup>,</p> <p><b>Hardware</b> 3No. Royde and tucker Hi- Load 101 lift of type hinge 100mm x35mm blade size fitted 150mm, 1135mm and 2120mm from the head.</p> <p>1No Dorma Door Controls ltd TS71 overhead type closer 233mm x 60mm footprint size fitted to the exposed face as per manufactures instructions.</p> <p>1No. Eurospec tubular steel mortise latch 57xmm 26mm fitted 1400mm from the head of the leaf.</p> <p>1No. Aluminium lever type handle 100mm x 38mm footprint size</p> <p><b>Hardware Protection</b> Around hinges, hinge blade fully interrupts first seal and partially interrupts second seal with 3mm left continuous.</p> <p><b>Frame fixings</b> 4No. steel woodscrews per jamb.</p> <p><b>Doorset orientated</b> to open towards heating conditions</p>
<b>Test Standard</b>	BS 476 Part 22:1987
<b>Performance</b>	Integrity: 41 minutes Insulation: 41 minutes



## 16.18 Test report RF10149

The referenced test report, the essential details of which are summarised below, is the supporting data for ply faced Flamebreak doorsets with light weight core material.

<b>Date of test</b>	6 <sup>th</sup> October 2010
<b>Identification of test body</b>	Warringtonfire (Originally Chiltern international fire)
<b>Sponsor</b>	Pacific Rim Wood Ltd
<b>Tested Product</b>	Doorset A –left leaf; Doorset B- Right leaf
<b>Summary of test specimen</b>	<p><b>Dimensions leaf:</b> left leaf 2130mm(H) x 900mm(W) x 44mm(T) Right leaf 2130m (H) 896mm (W) x 44mm (T)</p> <p><b>Core/ Lipping</b> Both leaves Pacific Rim Wood Ltd Flamebreak 430 leaf, 8mm Sapele lipping on vertical edges, 20mm (T) Sapele lipping on head with a 14mm deep rebate.</p> <p><b>Overpanel</b> Pacific Rim Wood Ltd Flamebreak 430 - 400mm (H) x 1800mm (W) x 44mm (T), 20mm (T) Sapele Lipping on bottom edge only with 14mm deep rebate.</p> <p><b>Intumescent</b> 2No. Pyroplex 8500(FO) Rigid Box seals 10mm x 4mm fitted 10m apart 7mm from the exposed face. Pyroplex 8500 (FO) Rigid Box seal 10mm x 4mm fitted centrally in the rebate of the lipping. 2No. Pyroplex 8500 (FO) Rigid box seal 10mm x 4mm fitted 10mm apart, 8mm from the exposed face. 1No. Pyroplex 8500 (FO) Rigid box seal on Overpanel fitted in the rebate of the lipping.</p> <p><b>Hardware</b> 3No. Royde and tucker Hi- Load 101 lift of type hinge 100mm x35mm blade size fitted 150mm, 1000mm and 1850mm from the head. 1No Dorma Door Controls ltd TS71 overhead type closer 232mm x 58mm footprint size fitted to the exposed face as per manufactures instructions. 1No. Eurospec tubular steel mortise latch 57xmm 26mm fitted 1115mm from the head of the leaf. 1No. Aluminium lever type handle 100mm x 38mm footprint size.</p> <p><b>Hardware Protection</b> Around Hinges, hinge blade fully interrupts 1<sup>st</sup> seal and partially interrupts 2<sup>nd</sup> with 6mm remaining continuous. Around latch forend, latch forend fully interrupts both seals in edge of right leaf.</p> <p><b>Glazing</b> left leaf only-Pilkington Pyroshield 2 6mm (T) fitted 135mm from the leaf head, 170mm from the closing edge. Sight size 620mm (H) x 515mm (W) Overall aperture size 650mm (H) x 545mm (W) Expansion allowance 2-3mm all round</p> <p><b>Beading</b> Sapele 20mm (H) x 22mm (Deep) including a 5mm x 5mm bolection return and a 20<sup>o</sup> chamfer.</p>

	<b>Doorset orientated</b> to open towards heating conditions
<b>Test Standard</b>	BS 476 Part 22:1987
<b>Performance</b>	Integrity: 33 minutes Insulation: 33 minutes

## 16.19 Test report RF11026

The referenced test report, the essential details of which are summarised below, is the primary data for the Flamebreak design - specimen comprised ply face leaves with no perimeter stiles or rails.

<b>Date of test</b>	25 <sup>th</sup> January 2011
<b>Identification of test body</b>	Warringtonfire (Originally Chiltern international fire)
<b>Sponsor</b>	Pacific Rim Wood Ltd
<b>Summary of test specimen</b>	<p><b>Dimensions of leaf:</b> 2761mm (H) x 1236mm (W) x 44mm (T)</p> <p><b>Core/ Lipping</b> Pacific Rim Wood Ltd Flamebreak 430 Door blank, Sapele Lippings on all edges.</p> <p><b>Intumescent</b> Lorient Polyproducts Ltd LP2504 type 617 25m x 4mm fitted 10mm from the exposed face.</p> <p><b>Hardware</b> 4No. Royde and tucker Hi- Load 101 lift of type hinge 100mm x 35mm blade size fitted 150mm, 927mm, 1706mm and 2482mm from the head</p> <p>1No Dorma Door Controls ltd TS83V overhead type closer 293mm x 60 mm footprint size fitted to the exposed face as per manufactures instructions.</p> <p>1No. standard tubular steel mortise latch 57xmm 26mm fitted 1761mm from the head of the leaf.</p> <p>1No. Aluminium lever type handle 100mm x 38mm footprint size.</p> <p><b>Hardware Protection</b> Around hinges, hinge blade fully interrupts the seal in the frame reveal.</p> <p>Under hinge blade, Dufaylite Interdens 1mm (T) fitted under the hinge blade on frame and leaf.</p> <p>Around latch keep, latch keep fully interrupts seal in the frame reveal.</p> <p><b>Doorset orientated</b> to open towards heating conditions.</p>
<b>Test Standard</b>	BS 476 Part 22:1987
<b>Performance</b>	Integrity: 39 minutes Insulation: 39 minutes

## 16.20 Test report RF10128

The referenced test report, the essential details of which are summarised below, is supporting data for Flamebreak doorsets incorporating the Norsound NOR810S threshold dropseal.

<b>Date of test</b>	7 <sup>th</sup> October 2010
<b>Identification of test body</b>	Warringtonfire (Originally Chiltern international Fire)
<b>Sponsor</b>	Norseal Ltd
<b>Summary of test specimen</b>	<p><b>Dimensions of leaf:</b> Doorset A ULSASD - 2100mm (H) x 1000mm (W) x 44mm (T)</p> <p>Doorset B ULSADD - 2696mm (H) x 445/950mm (W) x 54mm (T)</p> <p><b>Core/ Lipping</b> Doorset A graduated density particleboard 38mm (T), nominal weight density 630kg/m<sup>3</sup>, 6mm (T) Sapele Lippings on all edges.</p> <p>Doorset B graduated density Particleboard 44mm (T), Nominal weight density 630kg/m<sup>3</sup>, 6mm (T) Sapele Lippings on all edges.</p> <p><b>Intumescent Doorset A</b>, Norseal Ltd NOR810S drop down seal 13mm (W) x 20mm (H) fitted centrally in the bottom edge of the leaf.</p> <p>Pyroplex Rigid box seal 8700 (FO) 15mm x 4mm fitted centrally in the frame head and jamb reveals.</p> <p>Norseal Ltd 710 single flipper seal 11mm x 10mm fitted in the frame reveal butted up to the stop.</p> <p><b>Doorset B:</b> 2No Lorient Polyproducts Ltd LP1504 type 617 15mm x 4mm fitted 7mm and 32mm from the exposed face (Closing edge of right leaf only)</p> <p>2No Lorient Polyproducts Ltd LP1504 type 617 15mm x 4mm fitted 7mm and 32mm from exposed face in frame reveals.</p> <p><b>Hardware</b> Doorset A 3No. Royde and tucker H102 bearing butt hinge 100mm x 35mm blade size fitted 150mm, 993mm and 1835mm from the head.</p> <p>1No Dorma Door Controls ltd TS83V overhead type closer 293mm x 60 mm footprint size fitted to the exposed face as per manufactures instructions.</p> <p>1No. Ingersol Rand Sashlock and Euro profile cylinder 235mm x 20mm forend size fitted 950mm from the threshold of the leaf.</p> <p>1No. Aluminium lever type handle 100mm x 38mm footprint size.</p> <p>Doorset B 4No. Royde and tucker H102 bearing butt hinge hinges 100mm x 35mm blade size fitted 150mm, 872mm, 1594mm and 2396mm from the head of leaf.</p>

	<p>1No Dorma Door Controls ltd TS83 overhead type closer 293mm x 60 mm footprint size fitted to the exposed face as per manufactures instructions.</p> <p>1No. Ingersol Rand Sashlock and Euro profile cylinder 235mm x 20mm forend size fitted 950mm from the threshold of the leaf.</p> <p>1No. stainless steel lever type handle 52mm (rose size)</p> <p>1No. Allart stainless steel flush bolt 900mm x 19mm fitted at the top of the left leaf edge.</p> <p>1No. Allart stainless steel flush bolt 203mm x 19mm fitted at the bottom of the left leaf edge.</p> <p><b>Hardware Protection</b> Doorset A Around hinges, hinge blade fully interrupts seal in frame reveal.</p> <p>Under hinge blade, 1mm (T) Interdens fitted under the hinge blade on frame and leaf.</p> <p>Under latch forend, Norseal 2.0-100 x 30 R/SA graphite type 2mm (T) fitted under the latch forend.</p> <p>Around latch keep, latch keep fully interrupts seal in frame reveal.</p> <p>Under latch keep, Norseal 2.0-100x30 R/SA graphite type 2mm (T) fitted under the latch keep.</p> <p>Doorset B Around hinges, hinge blade fully interrupts 1<sup>st</sup> seal and partially interrupts 2<sup>nd</sup> seal with 10mm remaining continuous.</p> <p>Under hinge blade 1mm (T) Interdens fitted under the hinge blade on frame and leaf.</p> <p>Around latch forend, latch forend partially interrupts both seals with 10mm of each remaining continuous.</p> <p>Under latch forend, Norseal 2.0 -100x30R/SA graphite type 2mm (T) fitted under the latch forend.</p> <p>Under latch keep Norseal 2.0 -100x30R/SA graphite type 2mm (T) fitted under the latch keep</p> <p>Under flush bolts Norseal 2.0 -100x30R/SA graphite type 2mm (T) fitted under the flush bolts</p> <p><b>Glazing</b> Doorset A only CGI International Ltd Pyroguard 7.2mm (T) fitted 420mm from the leaf head, 195mm from the closing edge.</p> <p>Sight size 1145mm (H) x 150mm (W)</p> <p>Overall aperture size 1200mm (H) x 200mm (W)</p> <p>Expansion allowance 2-3mm all round</p> <p><b>Beading</b> Sapele 31mm (H) x19.5mm (Deep) including a 4.5mm x 7mm bolection return and 19<sup>0</sup> chamfer.</p>
--	--

	Beading fixings 60mm (L) steel pins fitted 50mm from corners at 150mm centres and at 30° to the face of the glass. <b>Doorset orientated</b> to open towards heating conditions	
<b>Test Standard</b>	BS 476 Part 22:1987	
<b>Performance</b>	Integrity Doorset A: 44 minutes Insulation:44 minutes	Integrity Doorset B: 65 minutes Insulation: 65 minutes

## 16.21 Test report Warres 316266

The referenced test report, the essential details of which are summarised below, is the supporting data for doorsets installed in softwood framed glazed screen, both incorporating the Lorient Polyproducts Ltd System 36 Plus glazing system.

<b>Date of test</b>	6 <sup>th</sup> March 2012
<b>Identification of test body</b>	Warringtonfire (Originally Chiltern international Fire)
<b>Sponsor</b>	Lorient Polyproducts
<b>Summary of test specimen</b>	<p><b>Overall dimensions of specimen:</b> 1490mm (H) x 1490mm (W)</p> <p><b>Door Leaf: 1394mm (h) x 671.5mm (w)</b> comprised a core of particleboard 44mm (T), installed with 3mm nominal gaps to frame.</p> <p><b>Intumescent</b> Lorient Polyproducts Limited LP1504DS intumescent seal to door frame fitted into a groove in the door frame head and jambs.</p> <p><b>Frame/Facings</b> Softwood frame, density 500-550kg/m<sup>3</sup>, 45mm x 95mm overall size,</p> <p><b>Hardware</b> 2No. Royde and Tucker H207 Butt Hinges</p> <p><b>Hardware Protection</b> None</p> <p><b>Frame fixings</b> frame fixed to aperture with Steel woodscrews and plastic plugs with calcium silicate board packers.</p> <p><b>Glazing:</b></p> <p>Glass in screen C3S Securiglass, Pyroacet, 6mm (T) Glass size- 663mm x1386mm, Aperture size 677mm x 1400mm</p> <p>Glass in door, Pilkington UK Ltd, Pyro-Tuf 6mm (T), Glass size 460mm x 1182mm, Aperture size 474mm x 1196mm.</p> <p><b>Glazing beading</b> Glazing beads to screen Lorient Polyproducts Limited Sapele hardwood 600 kg/m<sup>3</sup>, fixed with 40 mm long steel pins at 200 mm centres.</p> <p>Glazing beads to door Lorient Polyproducts Limited Sapele hardwood 600 kg/m<sup>3</sup>, fixed with 40 mm long steel pins at 200 mm centres.</p> <p>Glazing system to screen and door Lorient Polyproducts Limited System 36/6 Plus, 2 No. hardwood blocks, 4 mm x 10 mm x 10 mm to bottom edge only.</p> <p><b>Doorset orientated</b> to open towards heating conditions</p>
<b>Test Standard</b>	BS 476: Part 20: 1987
<b>Performance</b>	Integrity: 33 minutes at glazing in door leaf

## 16.22 Indicative Test report WF434693/LR Issue 2

The referenced test report, the essential details of which are summarised below, is the primary data for the ASSA Abloy M351 & M352M locks for 30 & 60 minute fire resisting application.

<b>Date of Test</b>	18 <sup>th</sup> January 2021
<b>Identification of Test Body</b>	Warringtonfire Testing and Certification Ltd.
<b>Sponsor</b>	ASSA Abloy Ltd
<b>Tested Product</b>	Latched, single action, double leaf doorsets - ULSASD
<b>Tested Orientation</b>	Both specimens Opening in towards heating condition
<b>Summary of Test Specimen</b>	<p>At the request of ASSA Abloy Ltd. the full test specification has not been provided, a copy of WF434693/LR Issue 2 is held in confidence by Warringtonfire.</p> <p><u>The test consisted of two doorsets</u></p> <p>Both doorsets incorporated disengaged ASSA Abloy M351 at the leading edge of the doorset and a M352M electronic lockset at the head of the doorsets.</p> <p><u>Hardware Protection:</u></p> <p>Intumescent Material: HELD ON FILE at Warringtonfire</p> <p>Doorset A: 1mm self-adhered to the body of the lock and 2mm bedded behind the strike plate.</p> <p>Doorset B: 1mm self-adhered to the body of the lock and 2mm bedded behind the strike plate.</p>
<b>Test Standard</b>	Pressure Conditions from BS EN 1363-1: 2020
<b>Performance</b>	<b>Doorset A : Integrity:</b> 68 minutes <b>Insulation:</b> 68 minutes <b>Doorset B : Integrity:</b> 41 minutes <b>Insulation:</b> 41 minutes

## Supplementary Data

Report No.	Configuration	Leaf Size (mm)	Test Standard	Performance (mins)
RF09105 (A: 20x4mm & B: 15x4mm Pyroplex)	A: ULSASD	2145 x 927 x 44	BS EN 1634-1	35
	B: ULSASD	2145 x 927 x 44		
WF137714 (Pyroplex glazing system)	Indicative	990 x 900 x 44	BS 476: Part 20: 1987	41
WF139878 (Pyroplex glazing system)	Indicative	990 x 990 x 44	BS 476: Part 20: 1987	29 (failure attributed to glass not glazing system)
A11129 Rev. E (CS Group Acrovyn & door edge protectors)	Various	Various	BS 476: Part 22: 1987	30
IF12011 (Norsound Vision 30)	Indicative	1052 x 1020 x 44	BS 476: Part 20/22: 1987	39
IF13061 (Norsound Universal 30)	Indicative	1052 x 900 x 64	BS 476: Part 20/22: 1987	96
A12161 (Norsound Vision fanlights & side screens)	Various	Various	BS 476: Part 22: 1987	30 & 60
IF13014 (Norsound NOR910 & NOR920)	Indicative	A: 1268 x 279 x 44	BS 476: Part 20/22: 1987	A: 48
		B: 1262 x 279 x 54		B: 74
A08001 Rev. D (Yeoman Shield/Lorient PVCu edge protectors)	Various	Various	BS 476: Part 22: 1987	30 & 60
RF10070 (Pyroguard EW30)	LSASD + Glazed screen	2040 x 915 x 44 Screen: 2950 x 2950	BS EN 1634-1 & BS EN 1363-1	33
RF10163 (Pyroguard EW30 MAXI)	ULSASD + Glazed screen	2040 x 926 x 44 Screen: 2950 x 2950	BS EN 1634-1 & BS EN 1363-1	37
RF00138 (Pyrodur 30-104)	ULSADD + Glazed screen	2147 x 850/850 x 44	BS EN 1634-1 & BS EN 1363-1	32
RF05036 (Pyrodur 60-10)	ULSASD + Glazed screen	2133 x 1037 x 54 Screen: 3000 x 3000	BS EN 1634-1 & BS EN 1363-1	64
RF05037 (Pyrostop 30-10)	ULSASD + Glazed screen	2130 x 1035 x 44 Screen: 3000 x 3000	BS EN 1634-1 & BS EN 1363-1	43
CF5140 (Pyroclear 30-001)	Certifire Certificate	Various	BS 476 Part/22: 1987	30
Chilt/A12005 Revision G (Safehinge ALUmax)	Various	Various	BS 476 Part 22: 1987	30 & 60
WF393276 B (Winkhaus Trulock)	ULSASD Fan and sidelight	2147 x 1001 x 44 Screen: 3000 x 3000	BS476 Part22: 1987	37



## Appendix B: Revisions

Rev.	WF Ref.	Date	Description
A	FEA/F00125	01.08.00	Inclusion of additional test evidence to justify the use of further facing materials. Recalculation of maximum approved leaf dimensions and justification for the alteration of leaf size.
B	Chilt/A01032	26.02.01	1. Inclusion of test evidence RF00166 and re-calculation of size range. 2. Assessment of facing range for 2440 x 1220 maximum leaf size. Assessment of softwood door frames for 2440 x 1220 maximum leaf size.
C	Chilt/A02194	04.10.02	Revalidation for a further five year period and minor alterations to the report format.
D	Chilt/A04051	09.06.04	Inclusion of test evidence from RF04011 including feature grooves and 6mm lippings.
E	Chilt/A05159	08.09.05	Revalidation for a further five year period and inclusion of test evidence from RF05041 including rebated meeting edges and alternative thicknesses of face materials.
F	Chilt/A07168	20.08.07	Inclusion of Lorient Type 617 intumescent seals and revalidation for 5 years.
G	Chilt/A08228	04.12.08	Inclusion of PU glueline for lipping doors, glazed apertures to 1.44m <sup>2</sup> , MDF door frames, coverage for 10 x 4 Pyroplex seals (design limitations apply), overpanels with a flush and rebated junction, Lorient Type 617 written into a separate Flamebreak document, addition of Pyroplex glazing system 30054 based on WF137714, addition of Pyroplex glazing system based on WF30049.
H	Chilt/A09152	22.12.09	Technical review and update of assessment format; evidence from test RF09105 to BS EN 1634-1 incorporated into document - Lorient Type 617 perimeter seals and large single leaf doors with Pyroplex seals. Amendment to facing thickness.
I	Chilt/A09152 Rev I	22.07.10	Edit to intumescent gaskets required for flush bolts and top pivots.
J	Chilt/A11055	04.04.11	Technical review and update of assessment. Evidence from test RF10149 and RF11026 has been included to permit reduced core density and large leaf sizes without perimeter framing. Assessment validated for a further 5 years.
K	Chilt/A13247	24.03.14	Technical review and update of assessment, with a further five year's validity. Inclusion of CS Group Acrovyn & edge protectors, Lorient System 36/6 Plus, Pilkington Pyroclear 30-001 glass, Norsound Vision & Universal 30 glazing systems, Norsound Vision fanlights & side screens, CGI Pyroguard EW30, EW MAXI & EI30 glass for side screens and fanlights, Pilkington Pyroshield 2,

			Pyrodur 30-104, Pyrodur 60-10 and Pyrostop 30-10 glass for side screens and fanlights, Norsound intumescent edge seals, Norsound threshold seals, identification plates & an alternative perimeter intumescent seal specification using Pyroplex with double leaf doorsets.
L	CNA/F14088	22.04.14	Inclusion of updated Norsound Universal glazing diagrams, amendment to max permitted glass thickness for Norsound Vision glazing system, amendment to thickness of Norsound intumescent gasket required for flush bolts and inclusion of additional Norsound threshold seals
M	396630	23.02.18	Update to new format, technically reviewed and revalidated, include clarification to lipping sections. Section 9.1 amended and 9.1.1 added, clarification of concealed closers, inclusion of Yeoman Shield/Lorient PVCu edge protectors including additional data sheets
N	417524	14.12.20	Update to EN15725 format. Addition of test data for AV2 lockset, grooved facings and STS leaf edges seals.
O	502946	02.08.21	Addition of STS glazing system, Winkhaus Trulock, alternative overpanel fixing method and Safehinge ALUmax hinges.
P	529978 & 544569	27.08.24	Update to latest Warringtonfire template format. Addition of new test data in support of various hardware items (including concealed overhead closers), glazing options and details of T-shaped lippings. Addition of test WF535889 in support of amendment to multipoint lockset requirements and fanlight and sidelight framing.